

Solar Cells

ECE 3080/ECE 3040 Lecture

Dr. Doolittle

February 22, 2008

References –

PVCDROM by Dr. Honsberg at the University of Delaware

www.udel.edu/igert/pvcdrom

National Renewable Energy Laboratory

www.nrel.gov

University Center of Excellence for Photovoltaics

www.ece.gatech.edu/research/UCEP

Elaissa Trybus – elaissa@ece.gatech.edu

Georgia Institute of Technology

What is the highest efficiency Solar Cell?

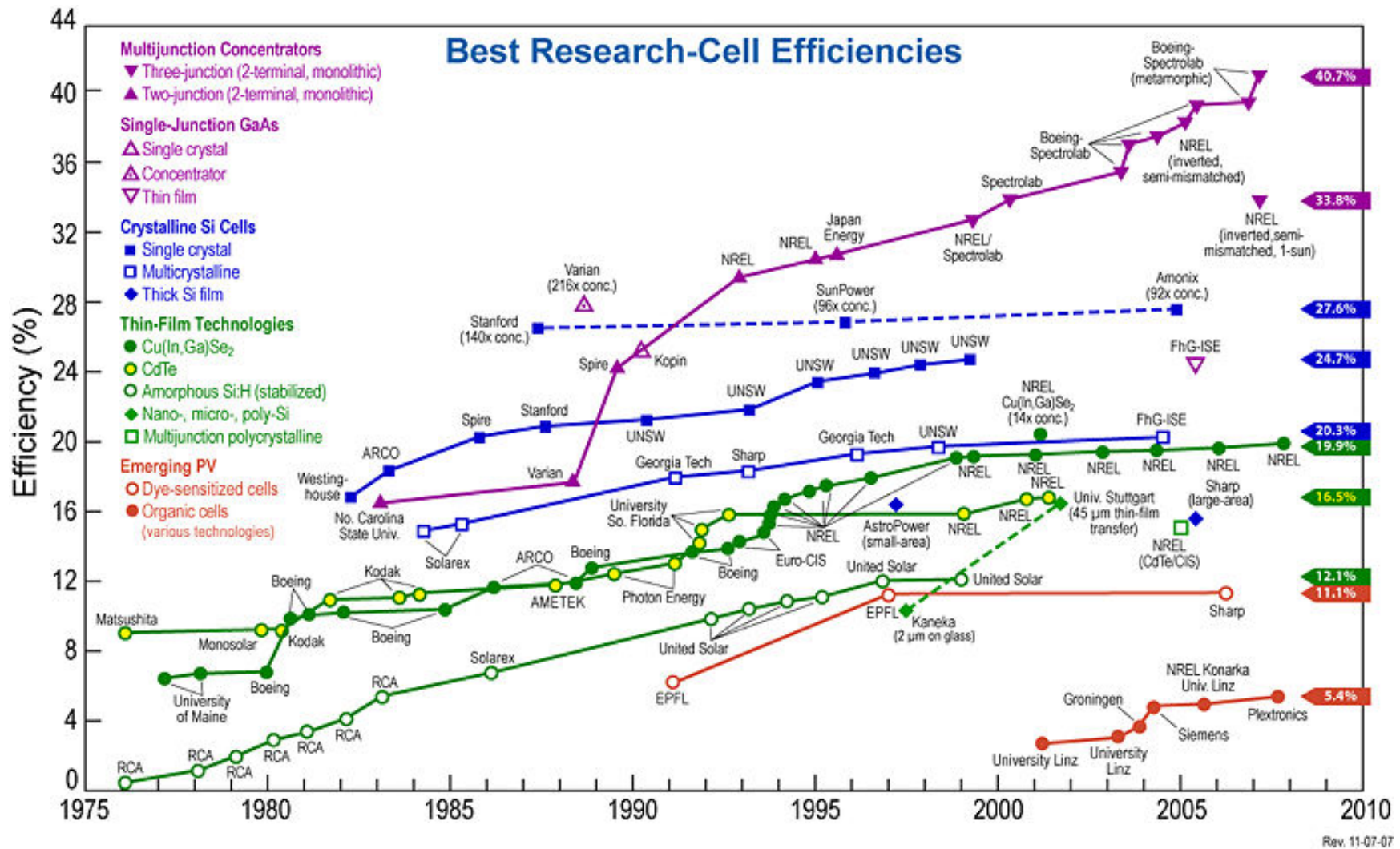

GT CRC Roof-Mounted PV System

- λ Largest single PV structure at the time of it's construction for the 1996 Olympic games
- λ Produced more than 1 billion watt hrs. of electrical energy that has been fed into the GT power grid

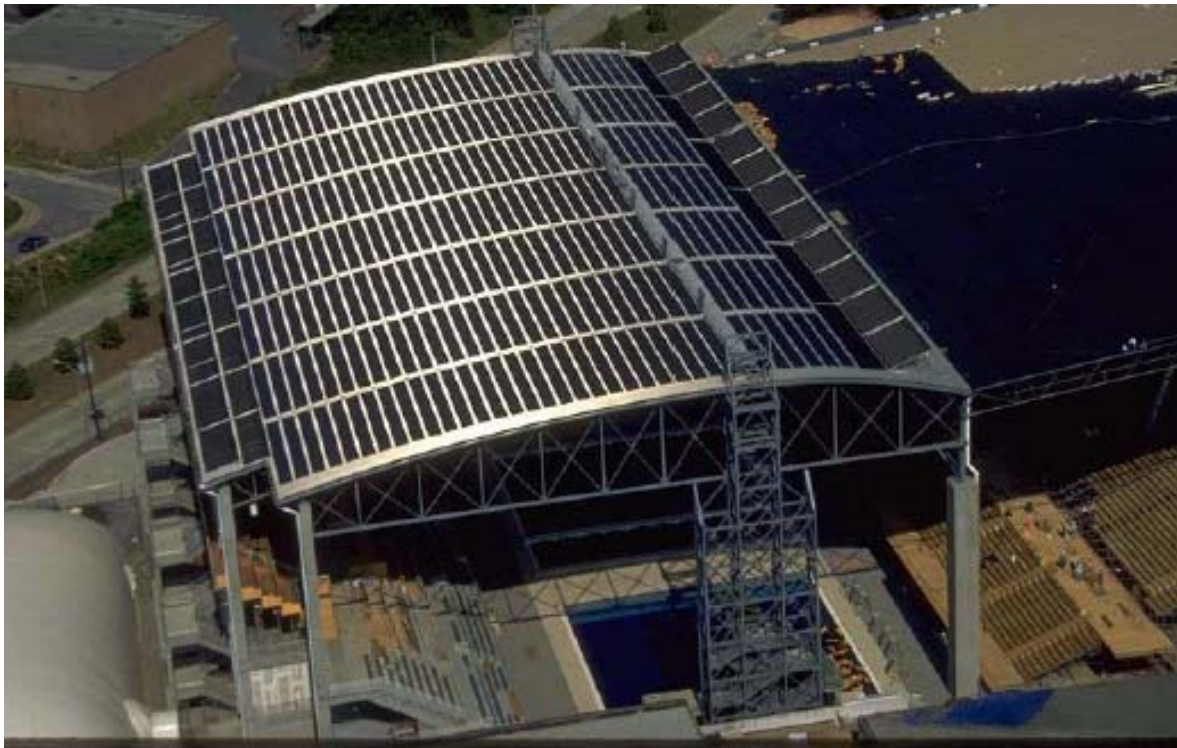

PV - Photovoltaic

Highest Efficiency Device

λ GaInP/GaInAs/Ge
by Spectrolab
(A Boeing Company)
achieved 40.7%
efficiency in 2007.

λ Current devices
employed on satellites
have efficiencies
~28.3%

λ An approximate device
structure →

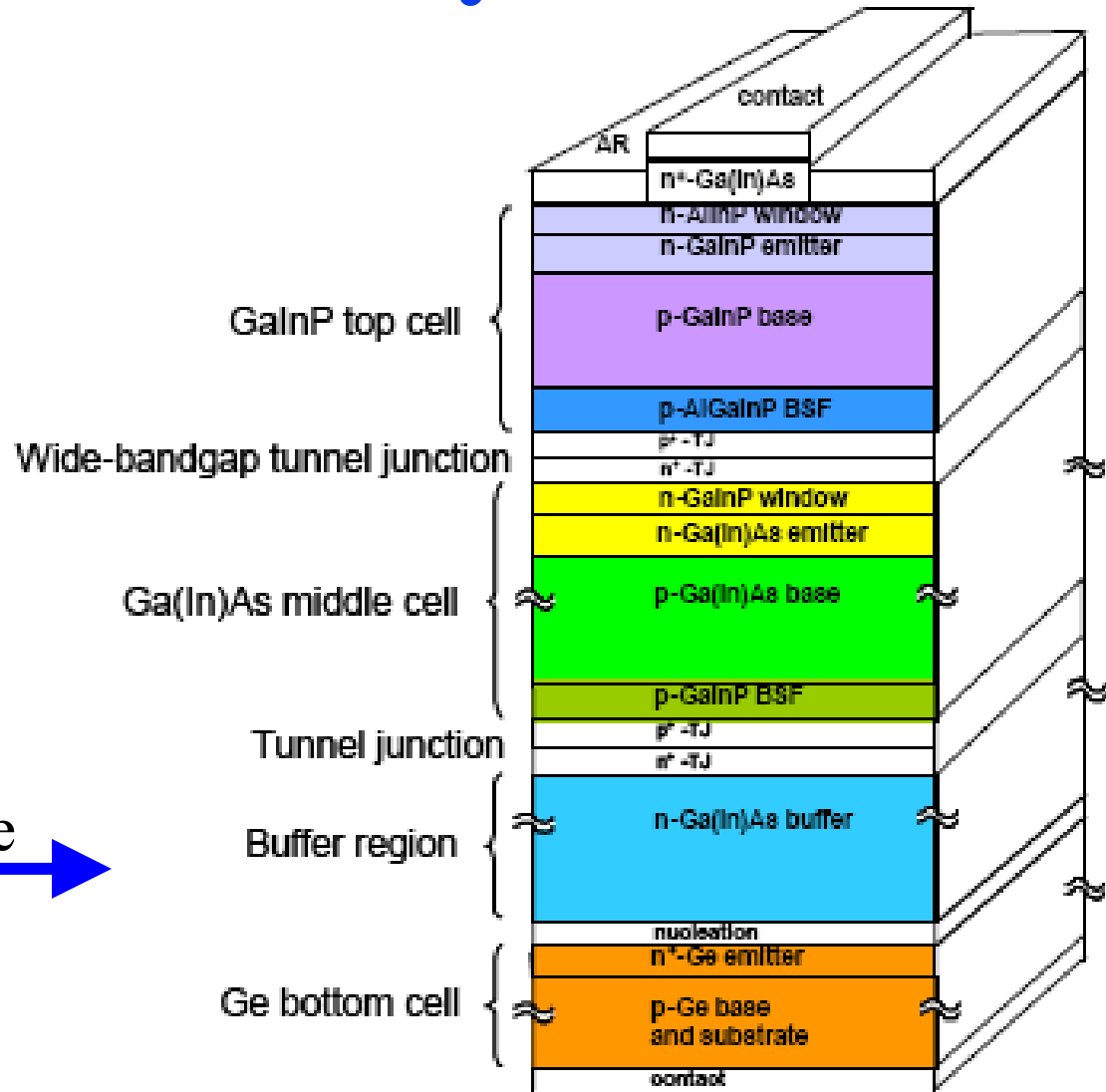

Energy of a Photon

$$E \text{ [eV]} = \frac{hc}{\lambda} = \frac{1.24}{\lambda[\mu\text{m}]}$$

$$h = 6.626 \times 10^{-34} \text{ [J}\cdot\text{s]}$$

$$c = 3 \times 10^8 \text{ [m/s]}$$

$$J = 1.602 \times 10^{-19} \text{ [eV]}$$

λ is the wavelength of light in meters

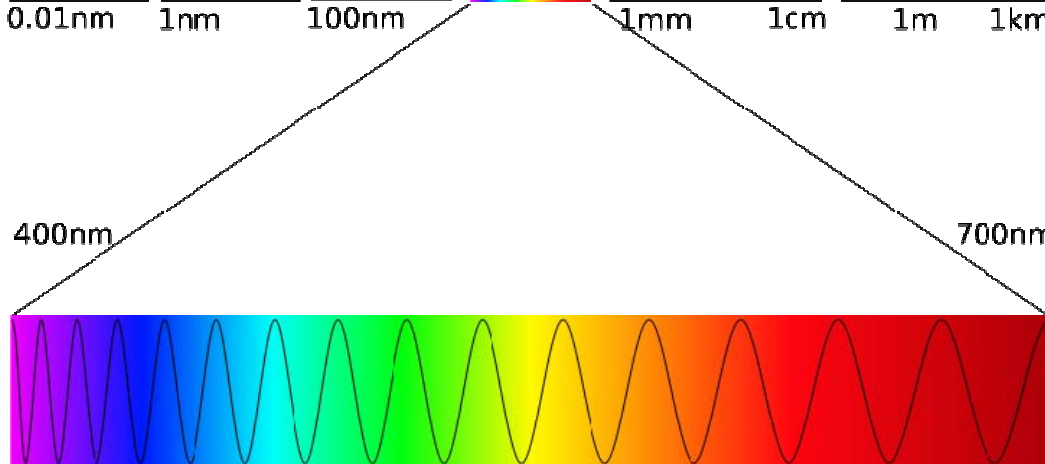
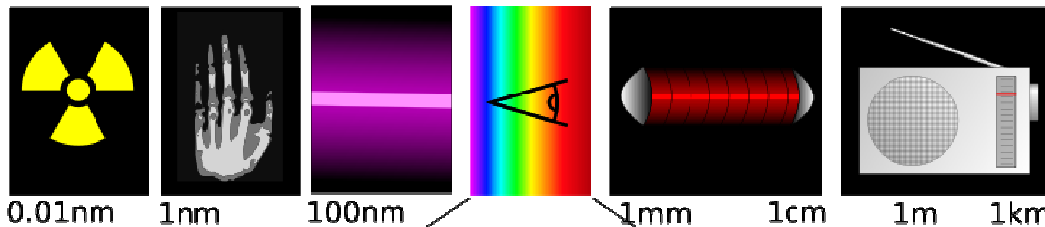

	Bandgap [eV]	Wavelength [μm]
Ge	0.67	1.85
Si	1.12	1.107
GaAs	1.42	0.873
GaN	3.4	0.365

Photovoltaic Effect

- λ Solar cells are:
 - p-n junctions
 - Minority carrier devices
 - Voltage is not directly applied
- λ The photocurrent produces a voltage drop across the resistive load, which forward biases the pn junction.

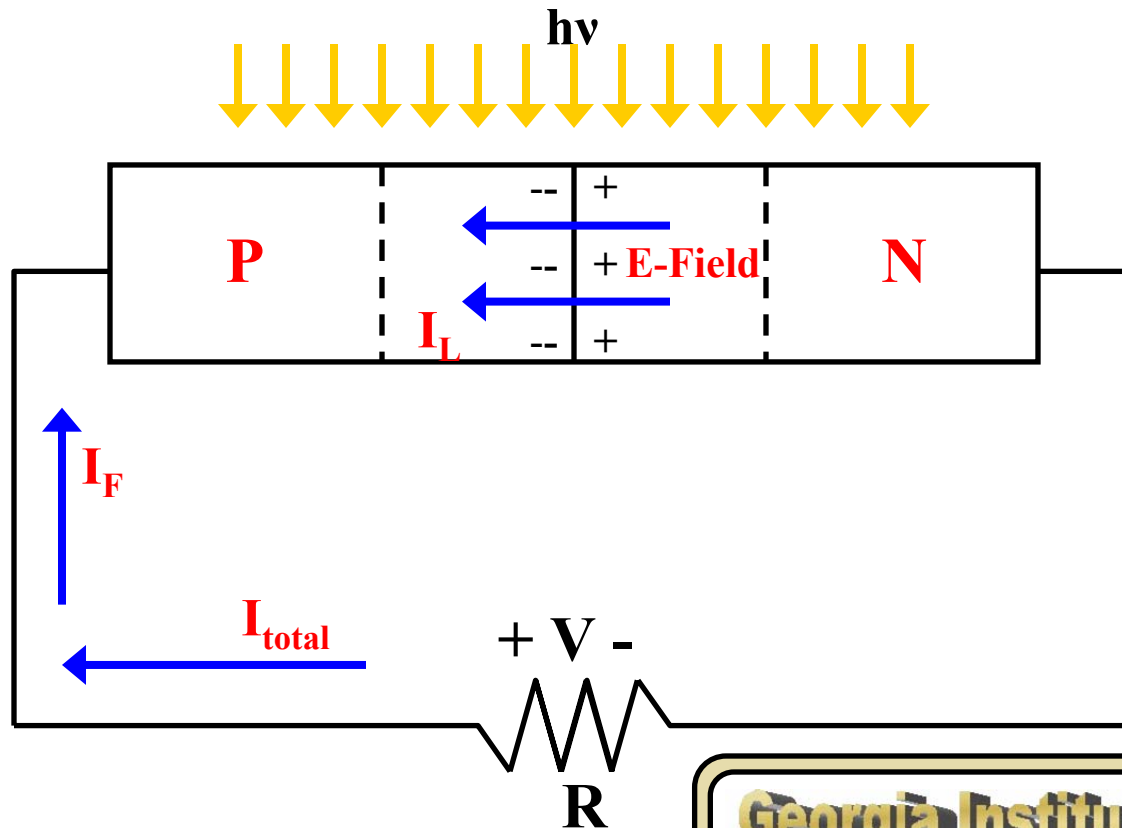

Photovoltaic Effect

λ Fundamental absorption is from:

- annihilation or absorption of photons by the excitation of an electron from the valence band to the conduction band
- leaves a hole in the valence band

λ Ideally, each incident photon with $E_{h\nu} > E_G$ will create one electron flowing in the external device

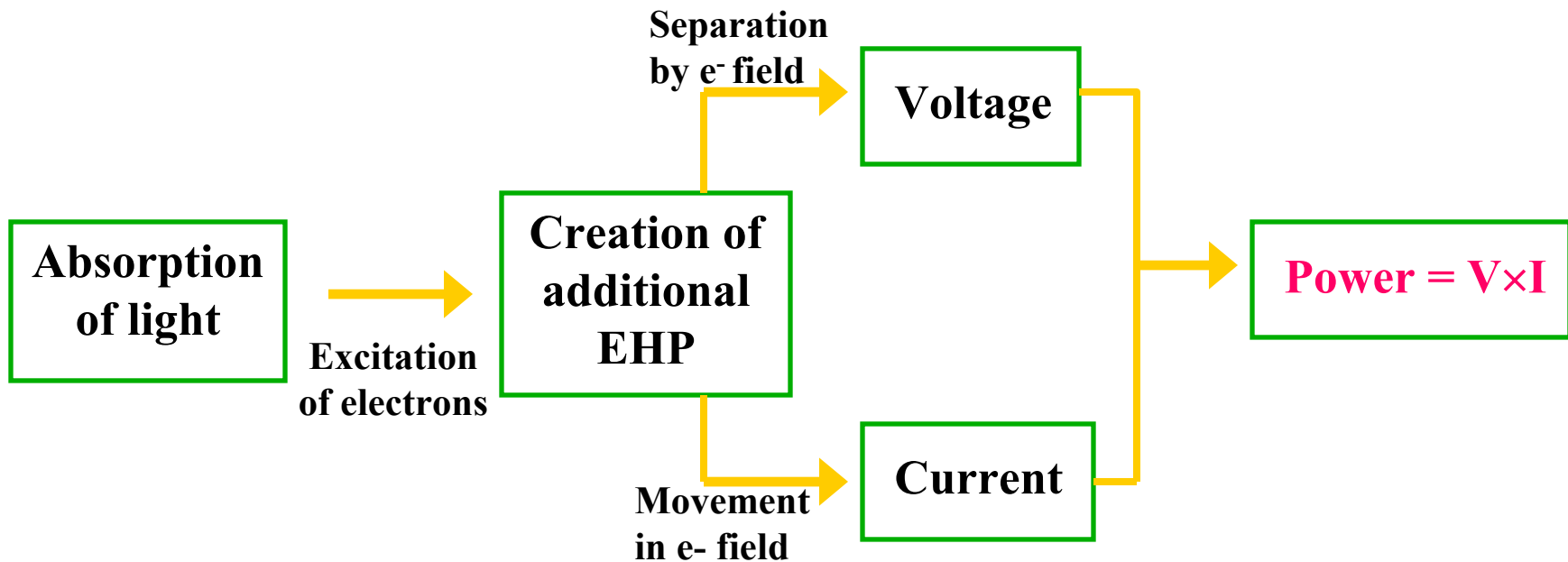

λ $E_{h\nu} < E_G$: semiconductor is transparent to light

Illumination and Generation

- ❖ Incident light on a solar cell causes an electron to be excited from the valence band into the conduction band (creating electron-hole pairs) everywhere in the device.
- ❖ $E_{hv} < E_G$: the device is transparent to the incident light.
- ❖ $E_{hv} \geq E_G$: photons are absorbed and EHP are photogenerated in the device.
- ❖ $E_{hv} > E_G$: energy generated is lost as heat to the device.

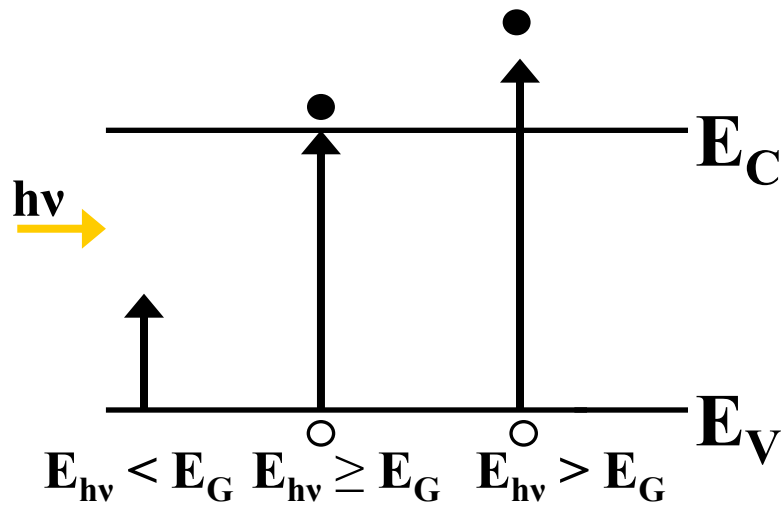

Diode at Equilibrium

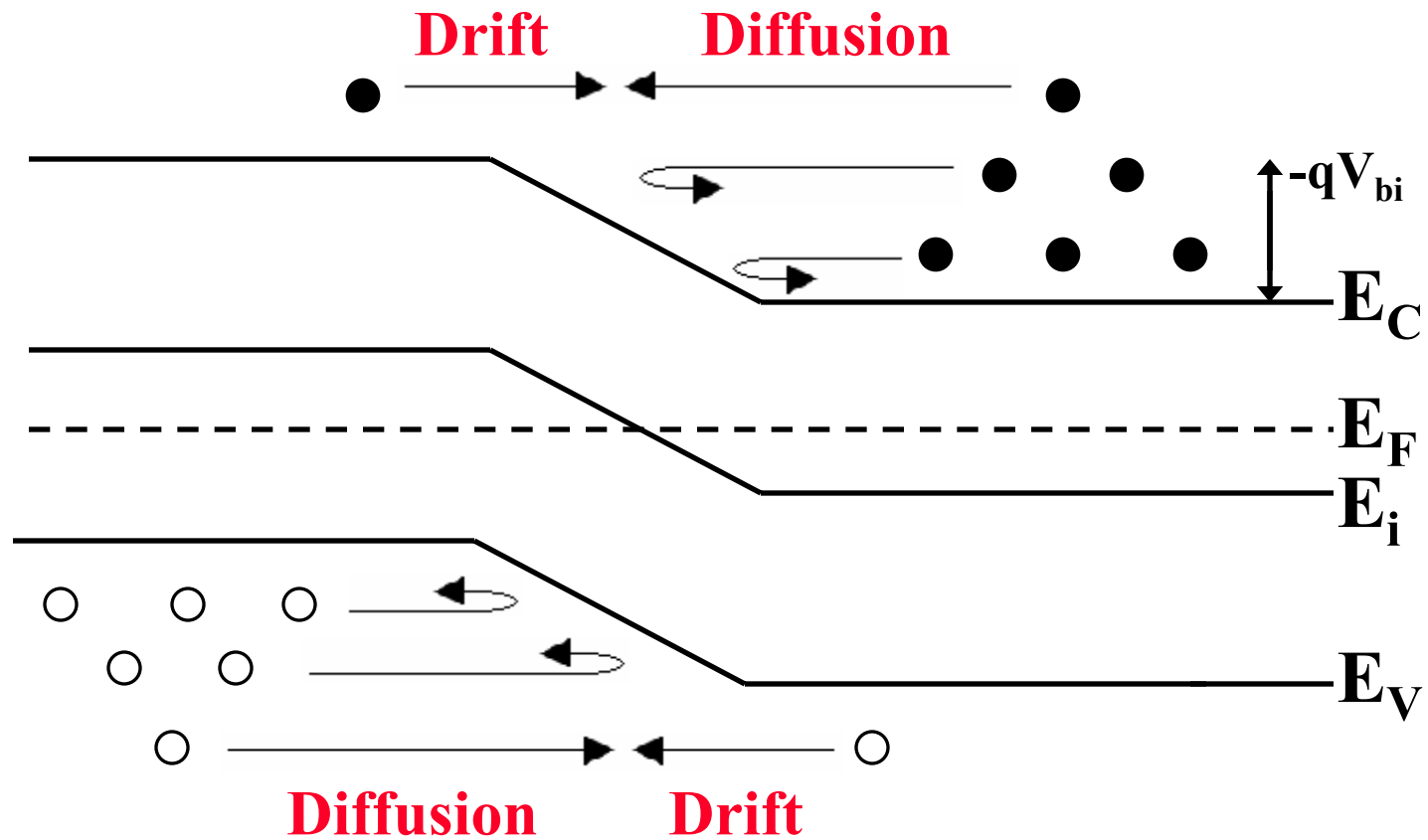

Depletion Region

- ❖ Every EHP generated in the:
 - Depletion region
 - Within a diffusion length ($L = \sqrt{D\tau}$) away from the depletion region are:
 - Swept across the junction by an electric field.
- ❖ Referred to as **photocurrent** and is in the “reverse bias” direction. All other EHP recombine before they can be collected.
- ❖ **Photocurrent** is always in the “reverse bias” direction, therefore the net solar cell current is also in the “reverse bias” direction.

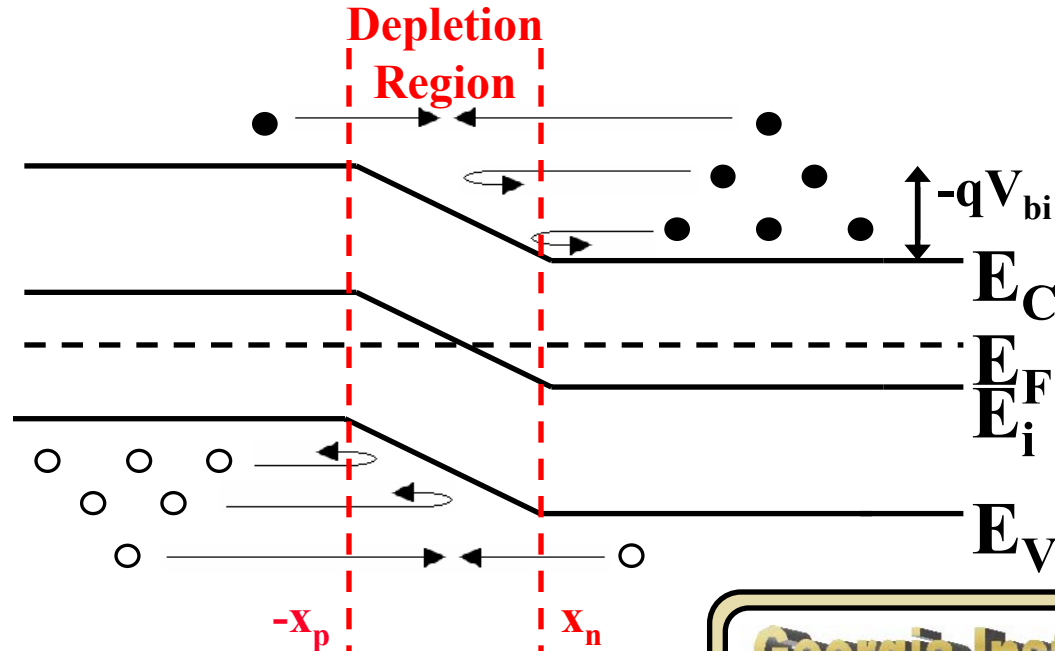

Forward Bias

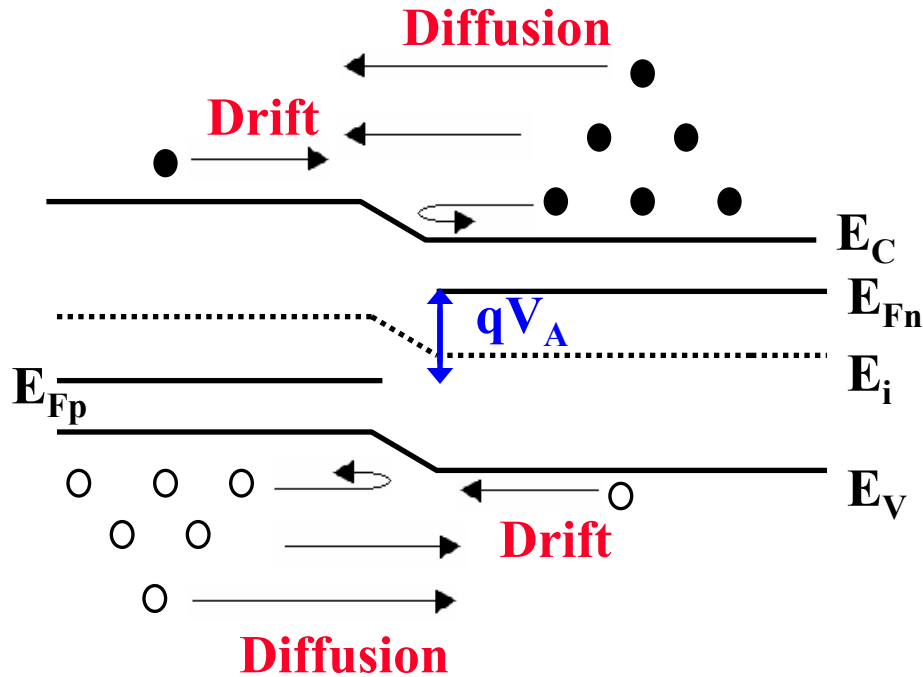

- ❖ Voltage applied externally.
- ❖ Current is dominated by Diffusion.

Photogeneration

- ❖ Voltage is generated internally from EHP being swept across the junction by an electric field.
- ❖ Current is dominated by Drift.

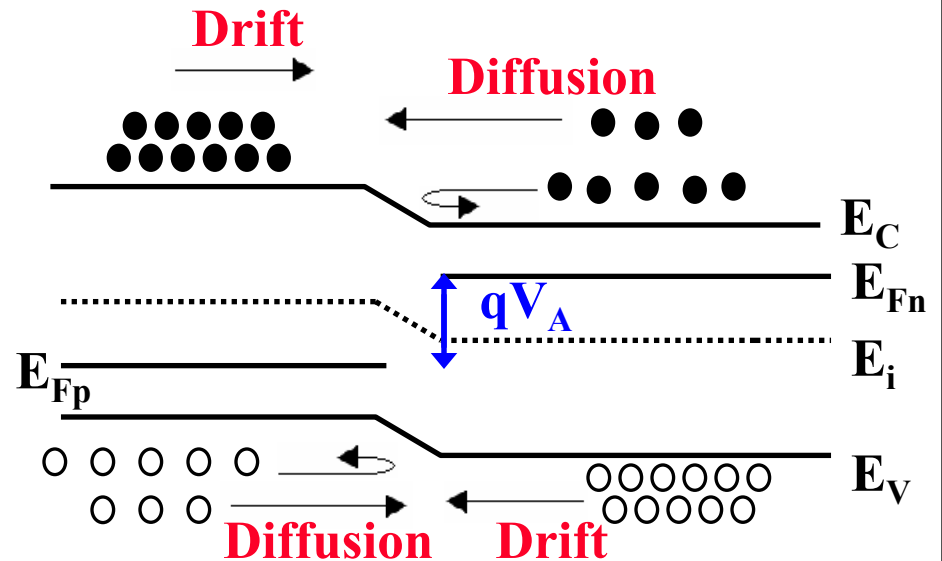

Law of the Junction

- ❖ V_A is the difference between Fermi level on the n-side and the p-side when a voltage is applied to a pn junction.

$$V_A = (kT/q) \ln \left\{ \frac{n_p(x=-x_p) \times p_n(x=x_n)}{n_i^2} \right\}$$

- ❖ It is related to the minority carriers in each region.
- ❖ V_A will be the same in the forward bias case and in the photogenerated case.

Current Collection

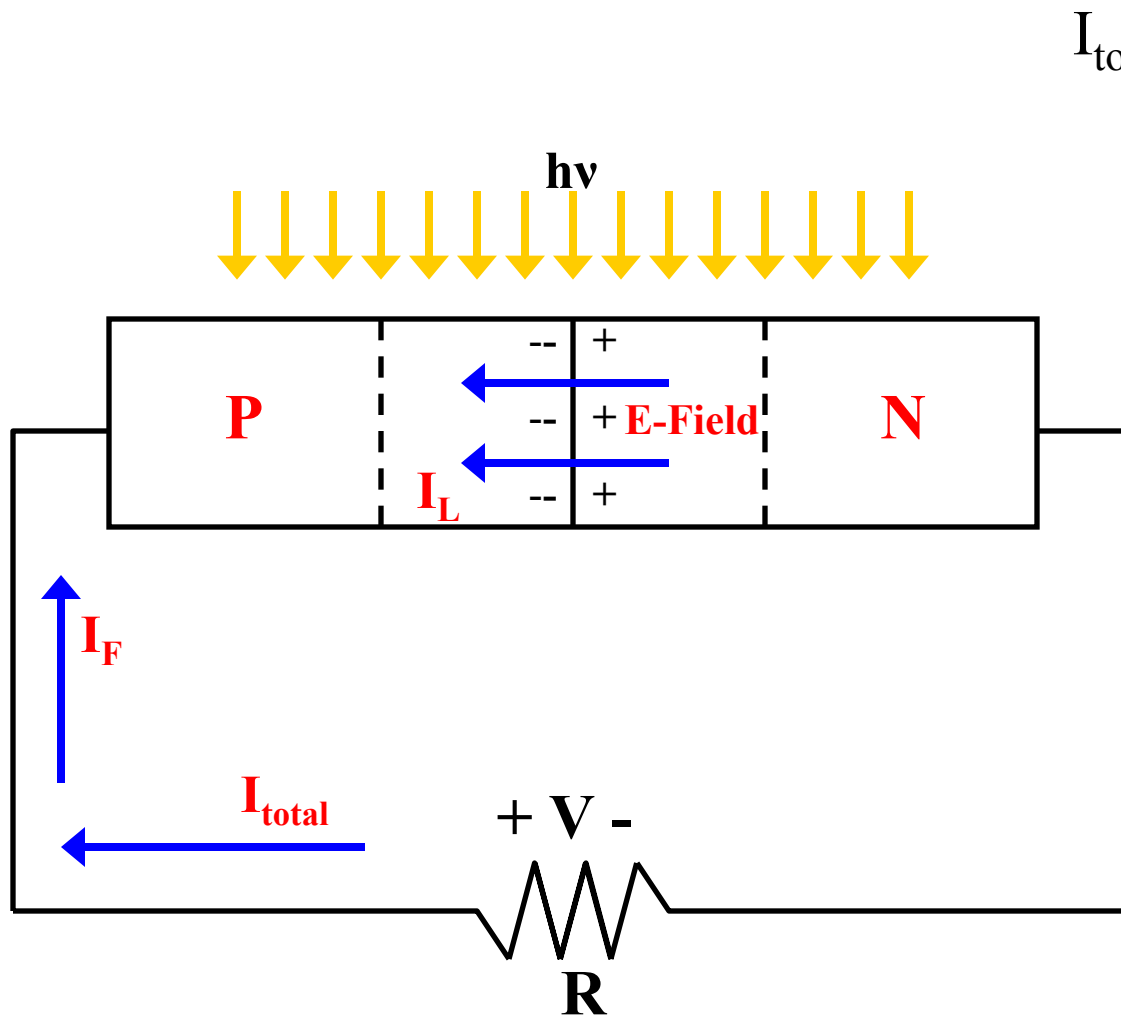

$$I_{total} = I_F - I_L$$

$$= I_s \{ \exp(qV/kT) - 1 \} - I_L$$

I_F = Forward-bias current

I_L = Photocurrent

I_s = Ideal reverse saturation current

Solar Cell Equivalent Circuit

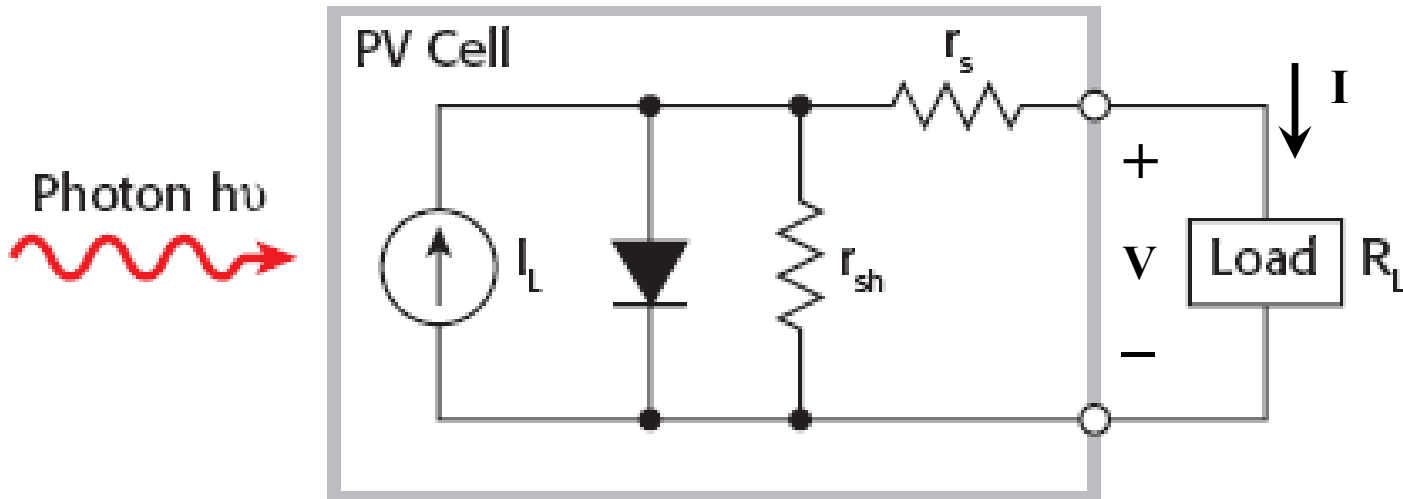

- λ Using the Ideal diode law: $I = I_0(e^{\{qV/kT\}} - 1)$
- λ $I = I_L - I_0(e^{\{V+Ir_s\}/nV_T} - 1) - (V + Ir_s)/r_{shunt}$
- λ I_L is the light induced current or short circuit current (I_{SC})
- λ $V_{OC} = kT/q (\ln \{[I_L/I_{OC}] + 1\})$
- λ r_s is the series resistance due to bulk material resistance and metal contact resistances.
- λ r_{sh} is the shunt resistance due to lattice defects in the depletion region and leakage current on the edges of the cell.
- λ $V_T = kT/q$
- λ n - non ideality factor, = 1 for an ideal diode

IV Curves

- λ V_m and I_m – the operating point yielding the maximum power output
- λ FF – fill factor – measure of how “square” the output characteristics are and used to determine efficiency.

$$FF = V_m I_m / V_{OC} I_{SC}$$

- λ η - power conversion efficiency.

$$\begin{aligned} \eta &= P_{max} / P_{in} \\ &= V_m I_m / P_{in} \\ &= FF V_{OC} I_{SC} / P_{in} \end{aligned}$$

- λ If $E_G \downarrow$ then:
 - More photons have the energy required to create an EHP
 - $I_{SC} \uparrow$ and $V_{OC} \downarrow$

- λ Large R_S and low R_{Sh} reduces V_{OC} and I_{SC}

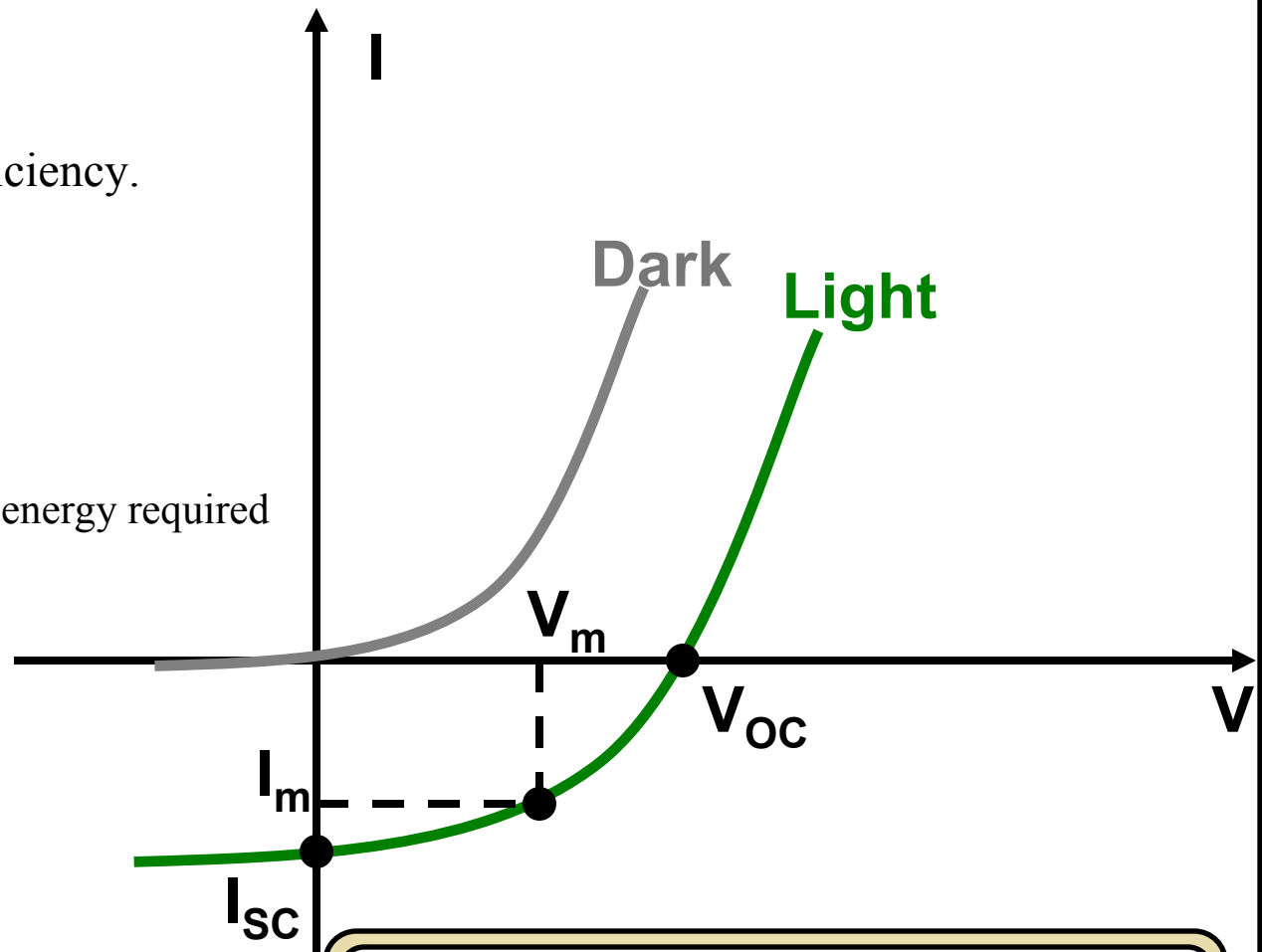

IC Curves – Dark measurement

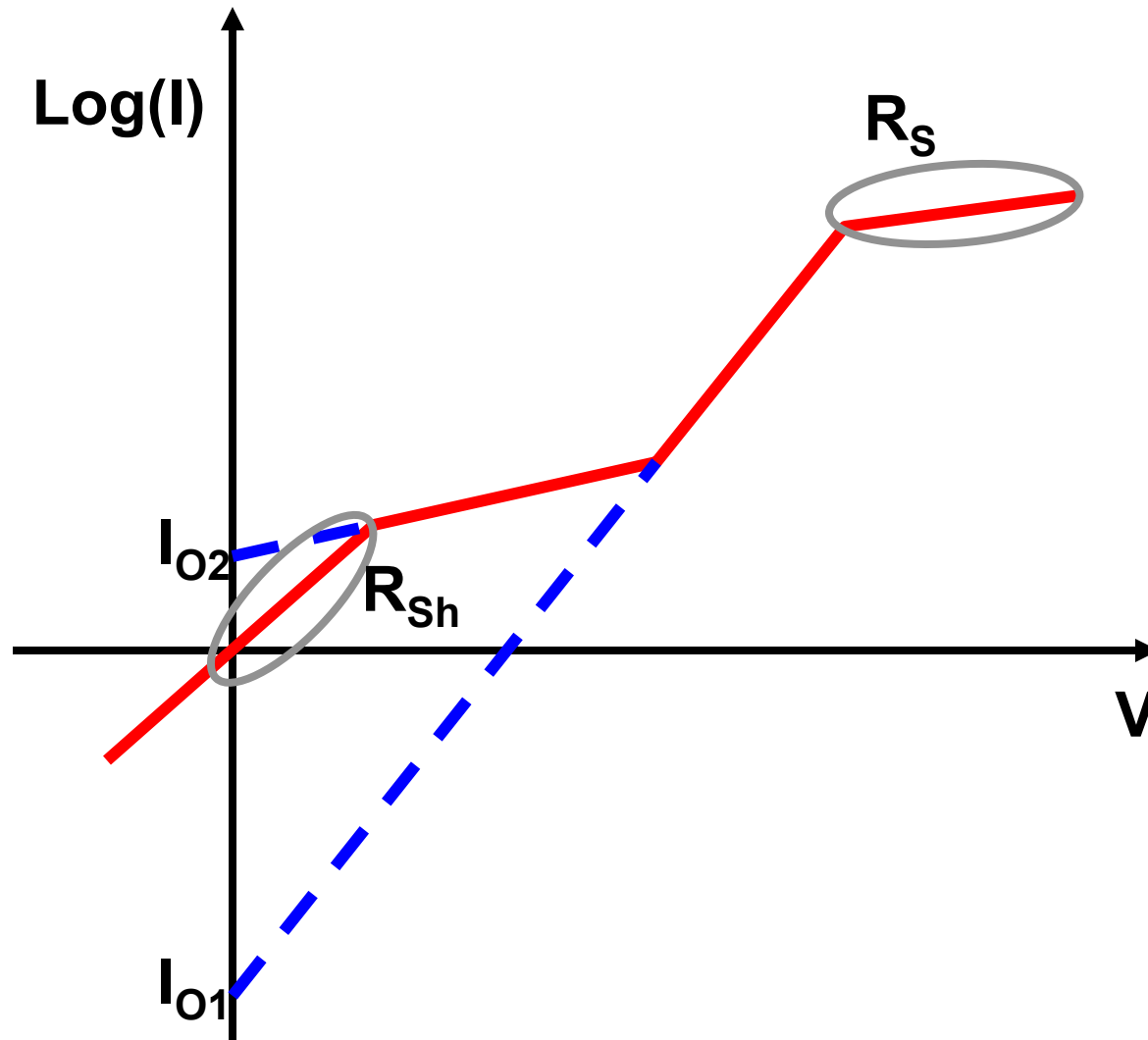

Highest Efficiency Device

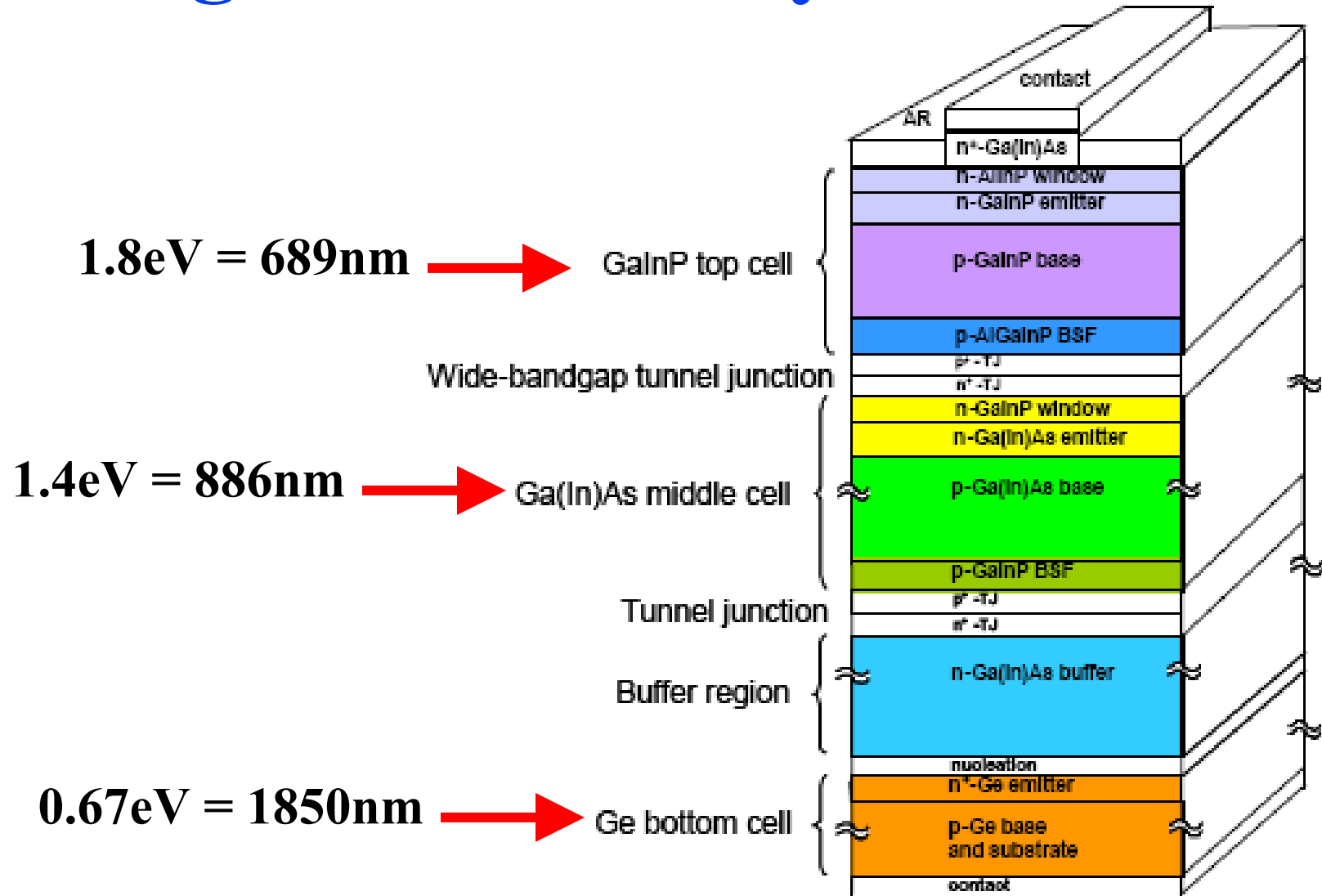

Si Technology

- λ Textured top layer
- λ Incident light will:
 - Become trapped
 - Bounced around in the texture
 - Absorbed in the device

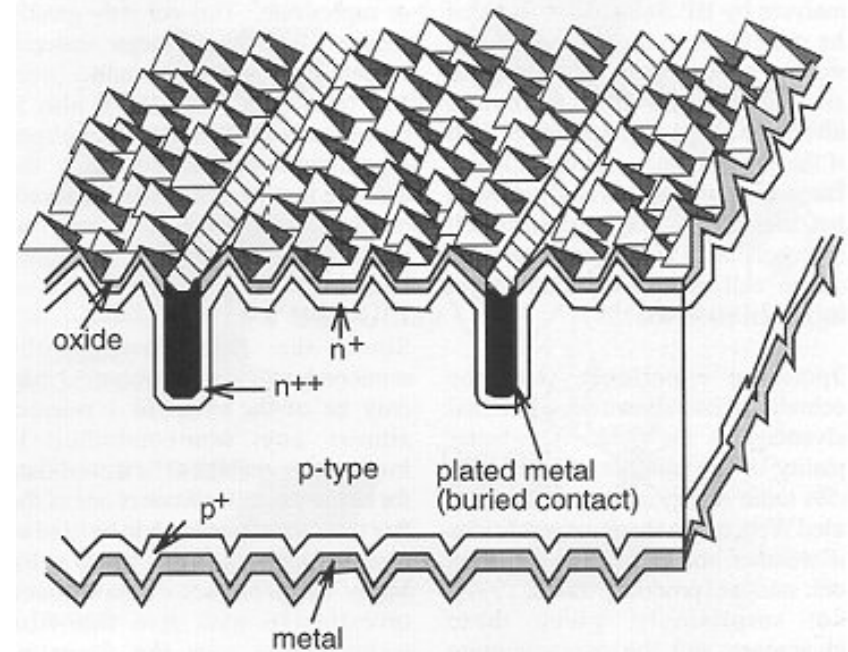
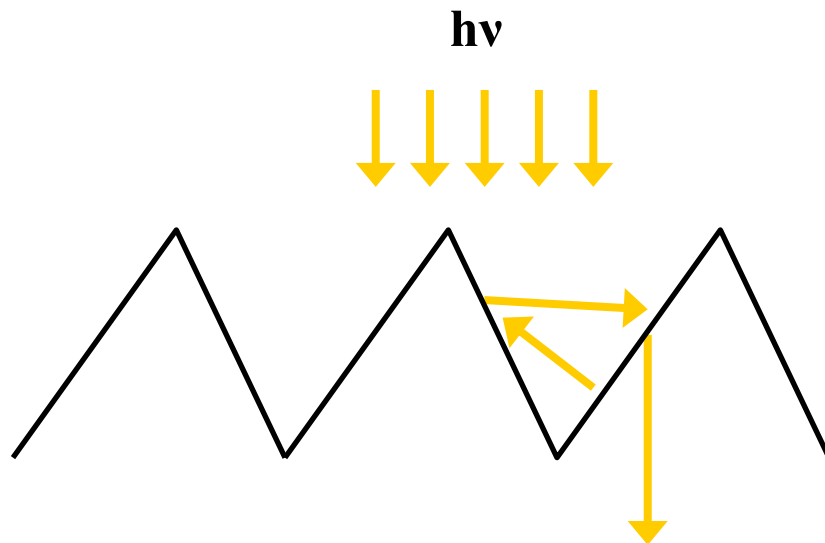

Dr. Doolittle's Solar Cell Research

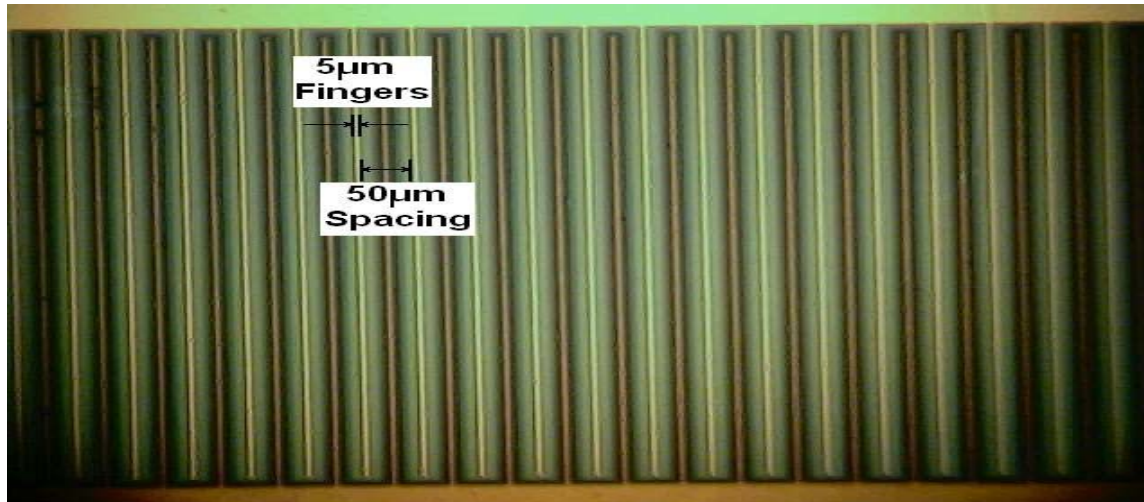

Fabricated MBE InGaN solar cell with interdigitated grid contacts

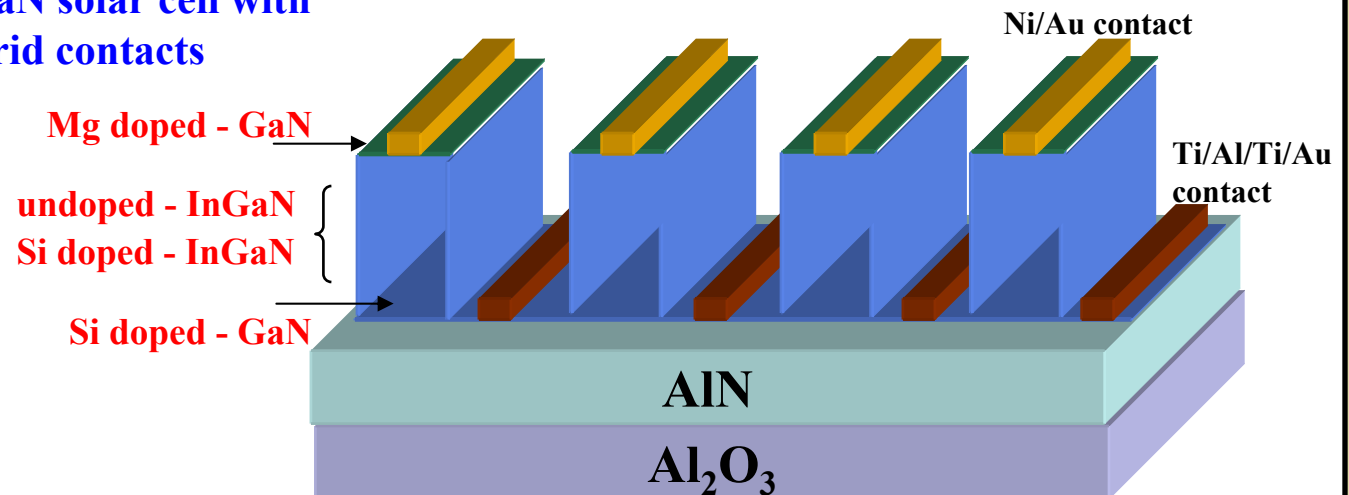

Schematic of the interdigitated grid contacts

InGaN bandgap:
 $2.8\text{eV} = 442\text{nm}$

What is a Tunnel Junction?

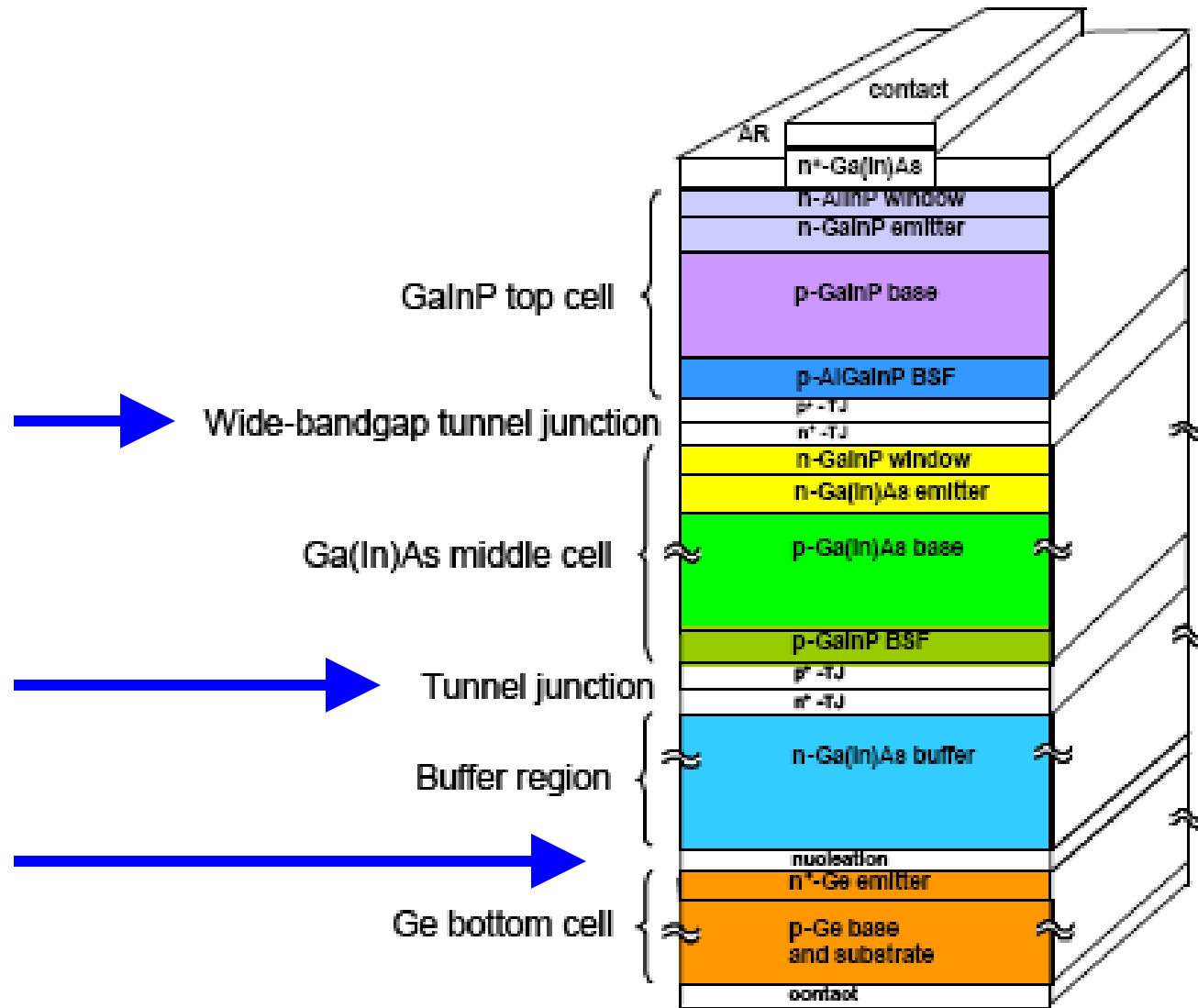

Tunnel Junction

Non-degenerately
Doped

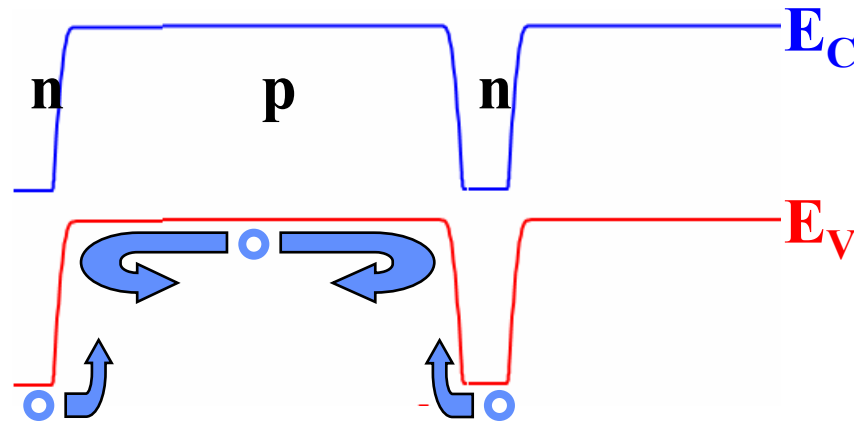

Tunnel junction
requires degenerate
doping!

Degenerately Doped – highly material

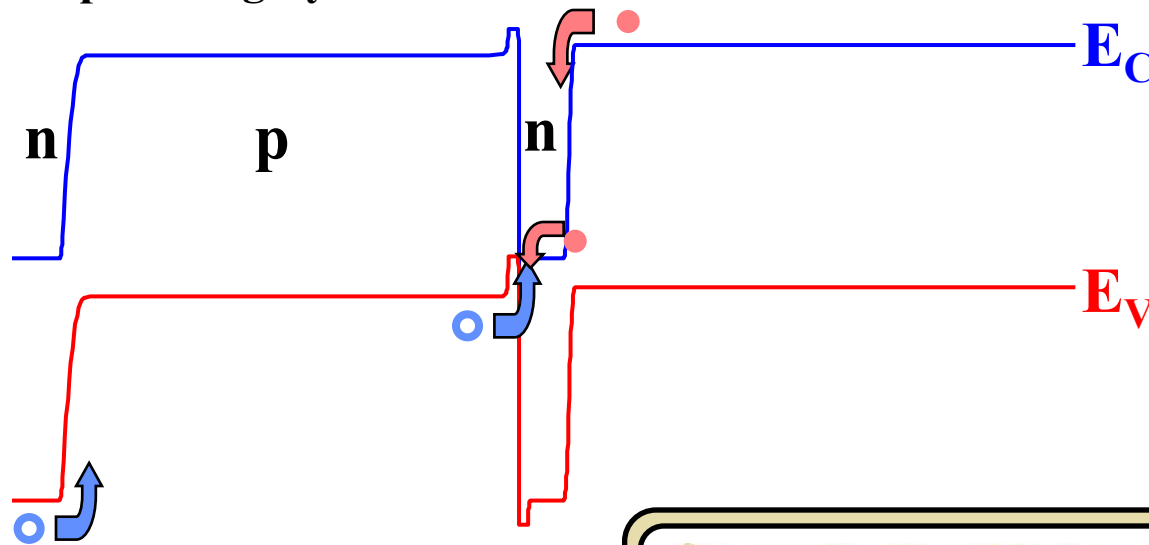

Tunnel Junction

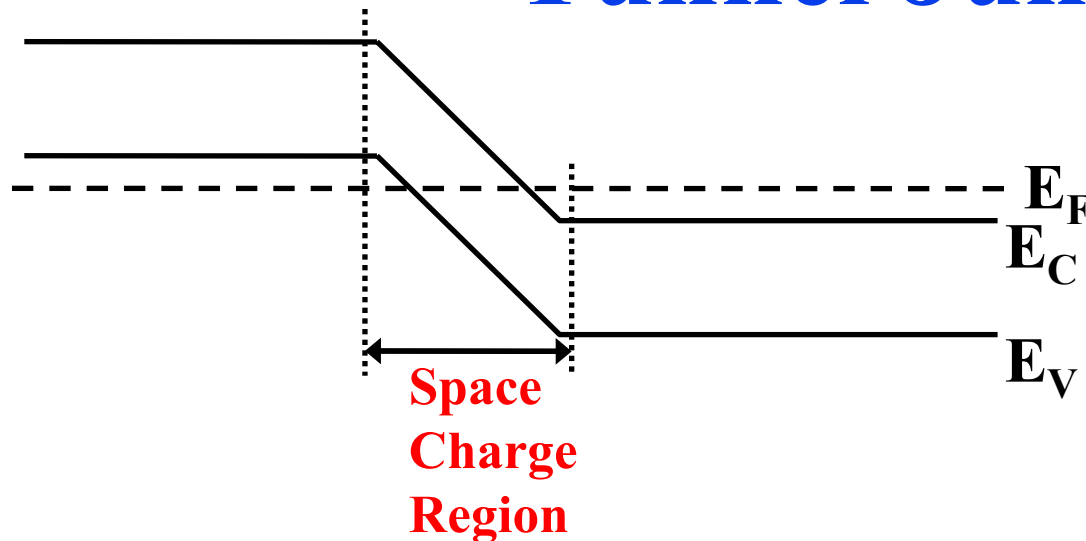

❖ Energy-band diagram in **thermal equilibrium** – n and p-region are degenerately doped

❖ Large **forward-bias** voltage – the maximum number of electrons in the n-region is opposite the maximum number of empty states in the p-region; maximum tunneling current is produced.

❖ Increased forward-bias voltage – the number of electrons directly opposite the holes decreases and the tunneling current decreases.

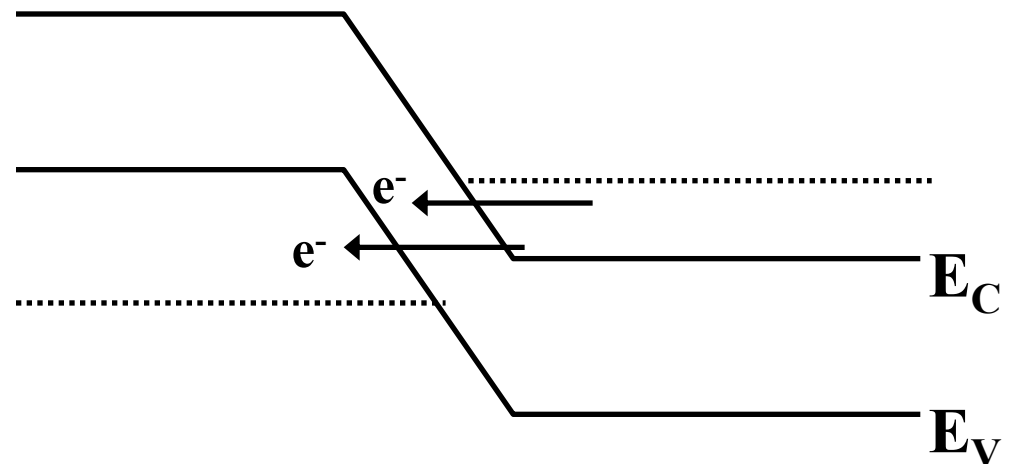

Non-Idealities

- ❖ Bulk defects – dislocations and stacking faults, due to lattice mismatch with the substrate.
- ❖ Surface recombination defects – EHP generated by the absorption of light can recombine before they cross the junction, therefore not contributing to the power output of the solar cell.
- ❖ Bulk recombination defects – EHP generated further away from the junction have a large probability of recombining before they reach the device terminals.
- ❖ Insufficient photon energy: $h\nu < E_g$
- ❖ Excessive photon energy : $h\nu > E_g$
- ❖ Solar cell is too thin – some of the light of the appropriate energy is not coupled into the cell and is passed through the device.
- ❖ Open circuit Voltage (V_{OC}) losses – recombination of EHP in trap levels in the depletion region that lowers V_{OC} .
- ❖ Fill Factor losses – related to V_{OC} , series resistance, and shunt resistance.
- ❖ Reflection losses

Anti-Reflection Coating

- ❖ Prevents incident light from reflecting off of the device.
- ❖ The AR coating needs to have the correct refractive index for the material system and be transparent.
- ❖ Deposited as noncrystalline or amorphous layer which prevents problems with light scattering at grain boundaries.
- ❖ A double layer AR coating reduces the reflection of usable sunlight to $\sim 4\%$.