

The Fundamentals of Compressive Sensing

Mark A. Davenport

Georgia Institute of Technology

School of Electrical and Computer Engineering



Sensor Explosion

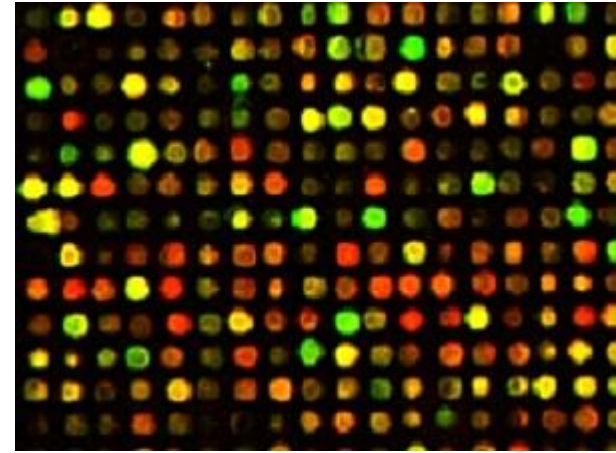

Data Deluge

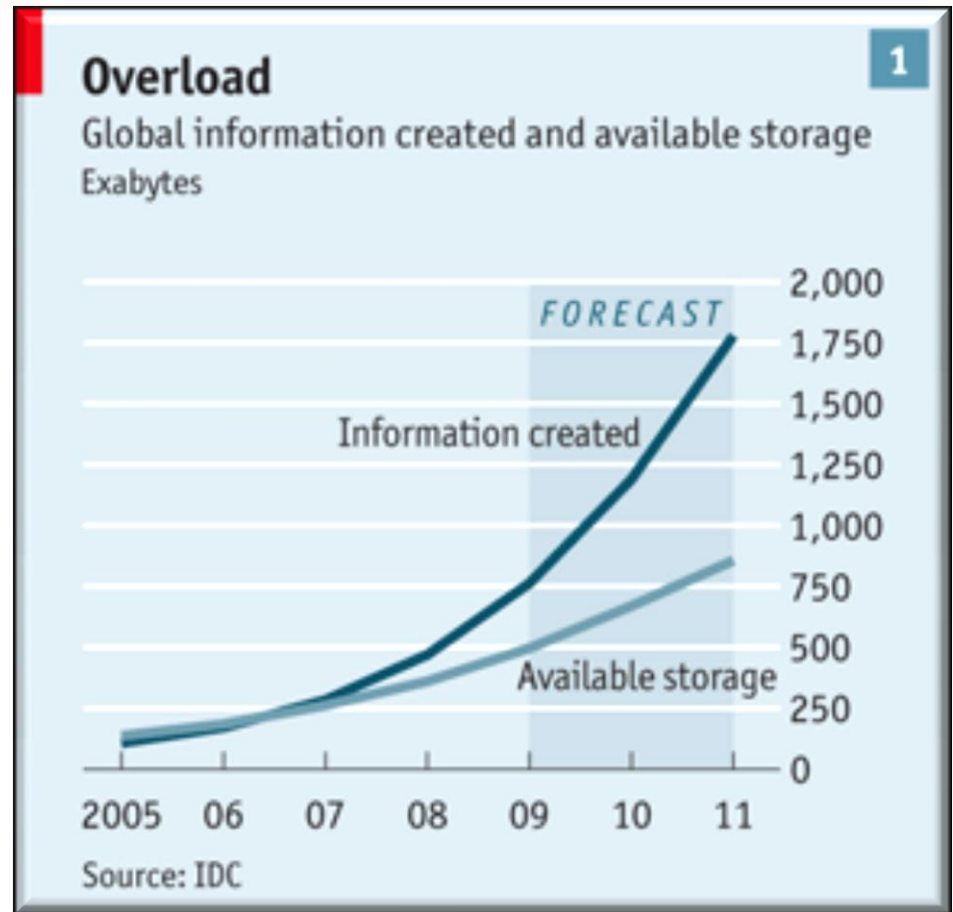

Digital Revolution

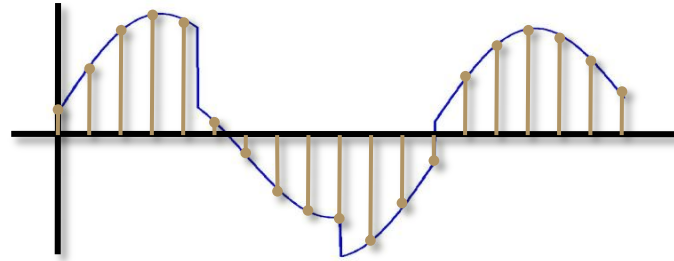

“If we sample a signal at twice its highest frequency, then we can recover it exactly.”

Whittaker-Nyquist-Kotelnikov-Shannon

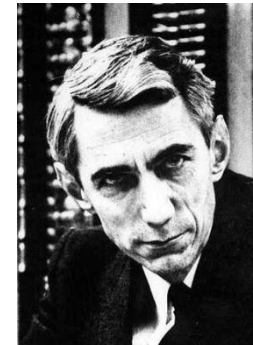

Dimensionality Reduction

Data with high-frequency content is often not intrinsically high-dimensional

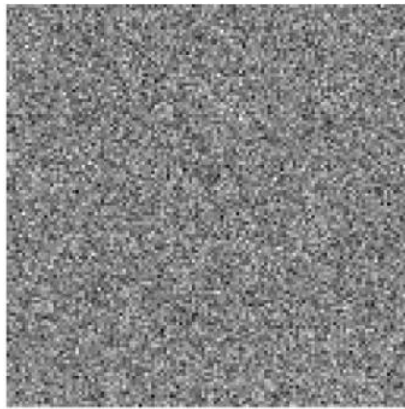

Signals often obey *low-dimensional models*

- sparsity
- manifolds
- low-rank matrices

The “intrinsic dimension” S can be much less than the “ambient dimension” N

Sample-Then-Compress Paradigm

- Standard paradigm for digital data acquisition
 - *sample* data (ADC, digital camera, ...)
 - *compress* data (signal-dependent, nonlinear)

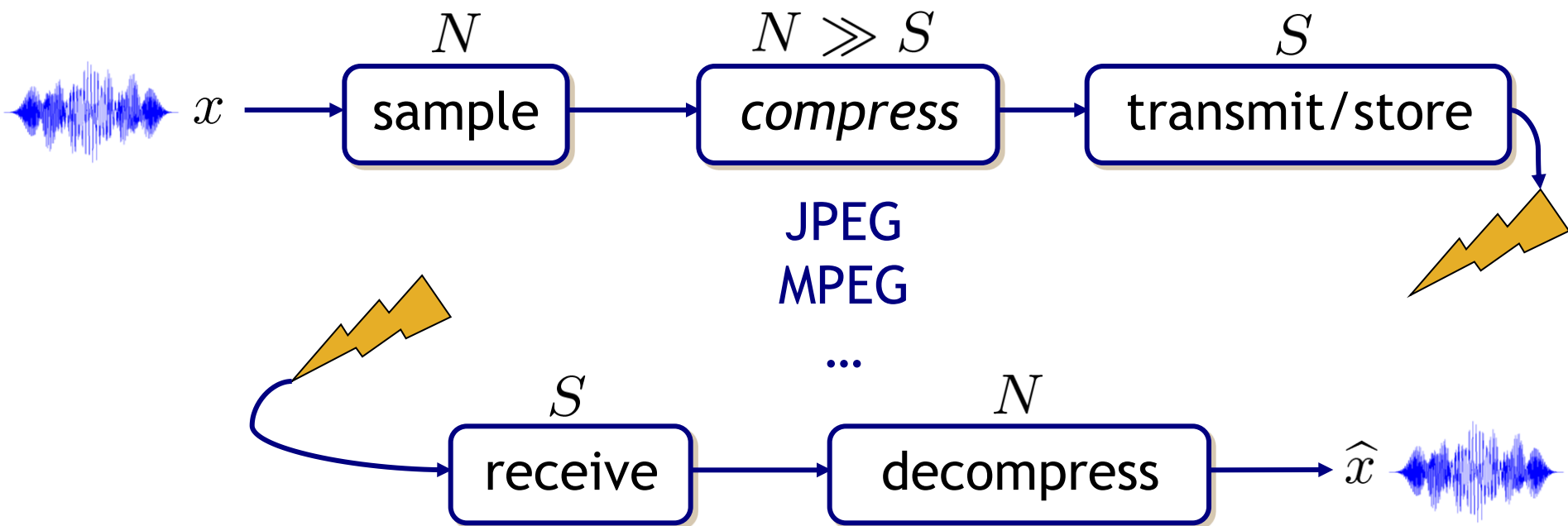

- Sample-and-compress paradigm is *wasteful*
 - samples cost \$\$\$ and/or time

Exploiting Low-Dimensional Structure

How can we exploit low-dimensional structure in the design of signal processing algorithms?

We would like to operate at the *intrinsic dimension* at all stages of the information-processing pipeline

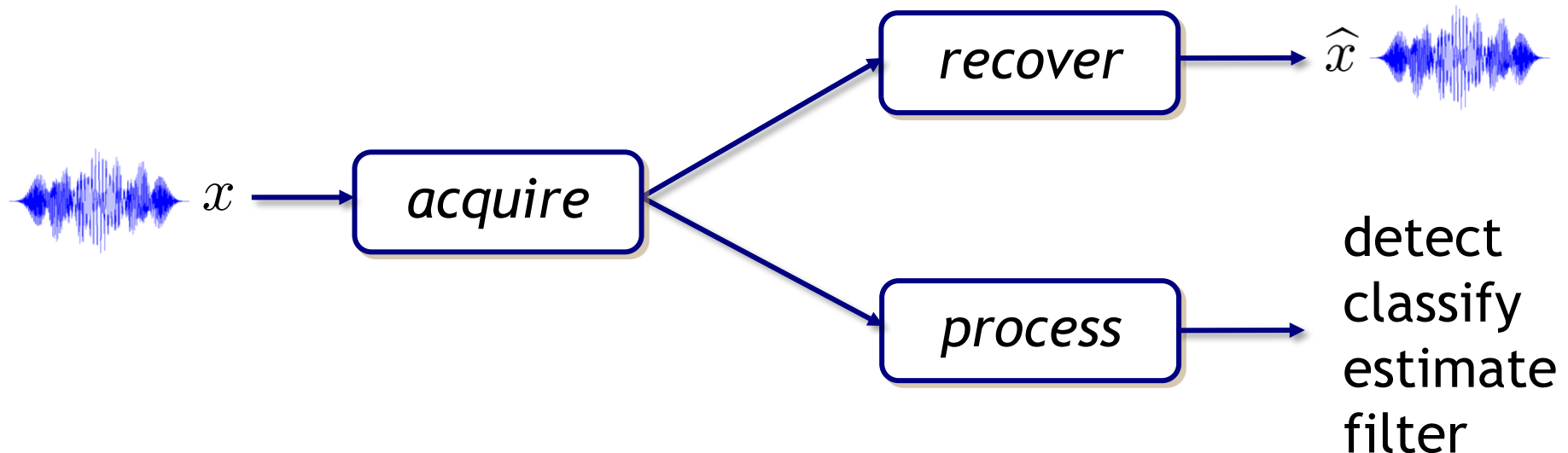

Compressive Sensing

Replace samples with general *linear measurements*

$$y = \Phi x$$

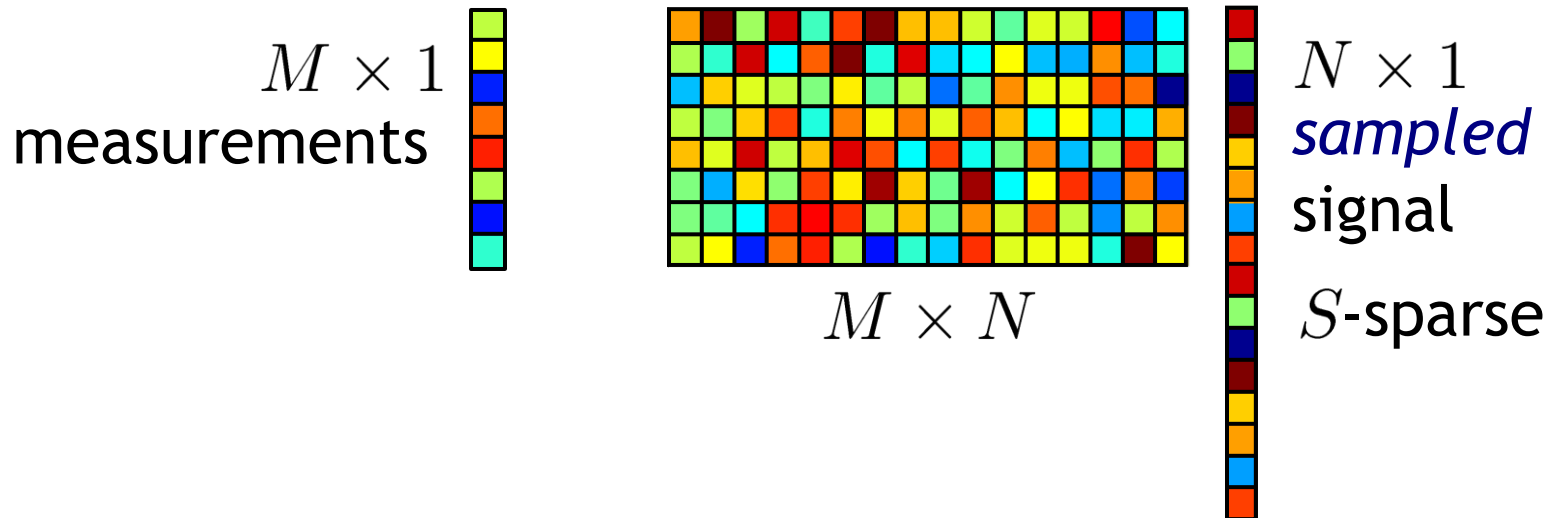

Sparsity

$$x = \sum_{j=1}^N \alpha_j \psi_j$$
$$= \Psi \alpha$$

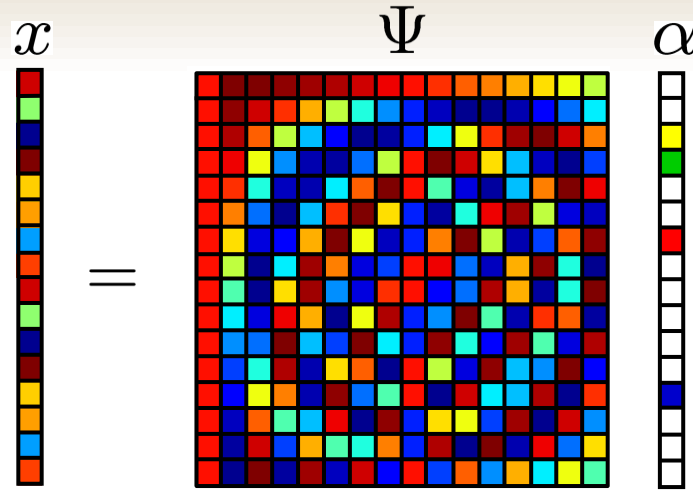

S nonzero entries

$$\|\alpha\|_0 = S$$

N
pixels

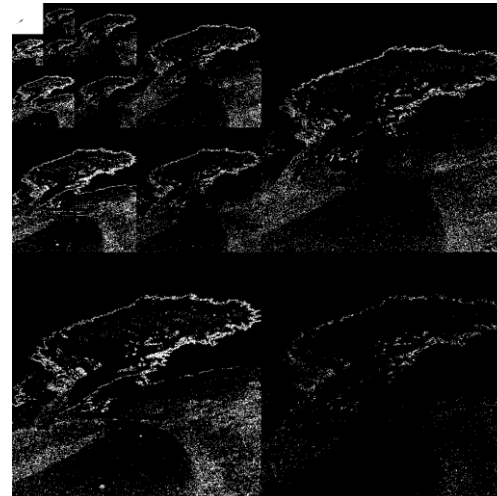

$S \ll N$
large
wavelet
coefficients

Sparsity

$$x = \sum_{j=1}^N \alpha_j \psi_j$$
$$= \Psi \alpha$$

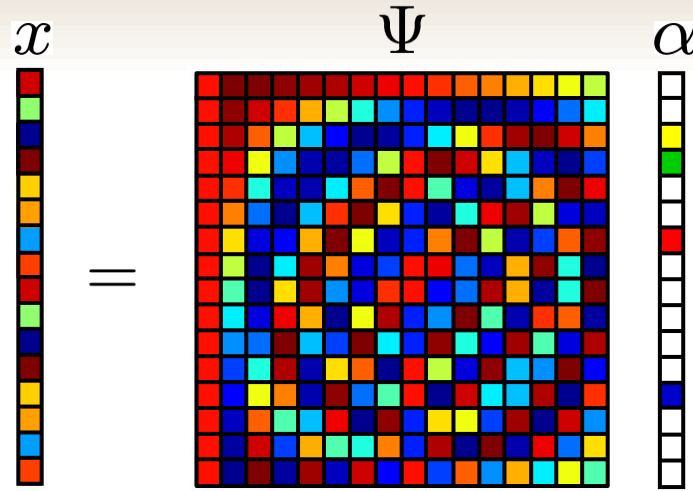

S nonzero entries

$$\|\alpha\|_0 = S$$

N samples

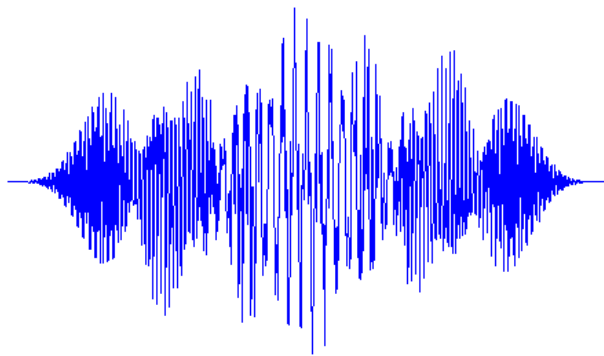

$X(f)$

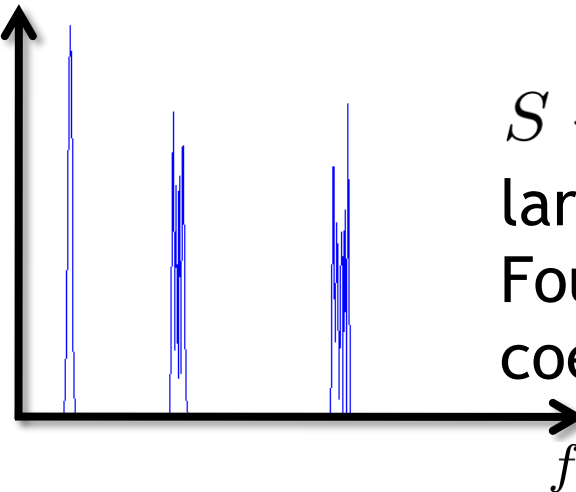

$S \ll N$
large
Fourier
coefficients

Sparsity

$$x = \sum_{j=1}^N \alpha_j \psi_j$$
$$= \Psi \alpha$$

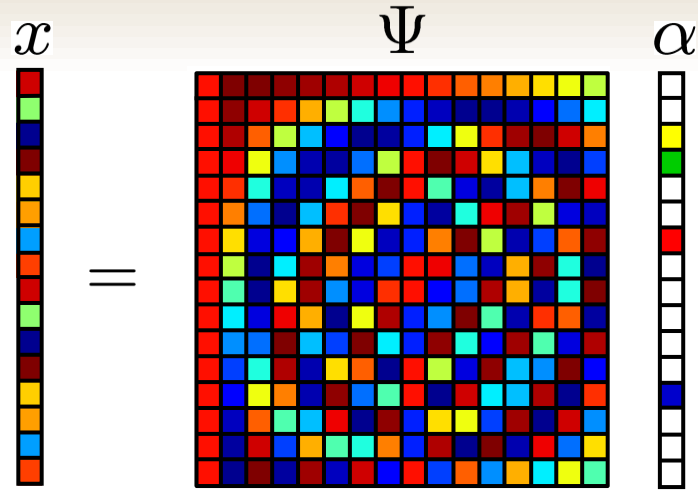

S nonzero
entries

$$\|\alpha\|_0 = S$$

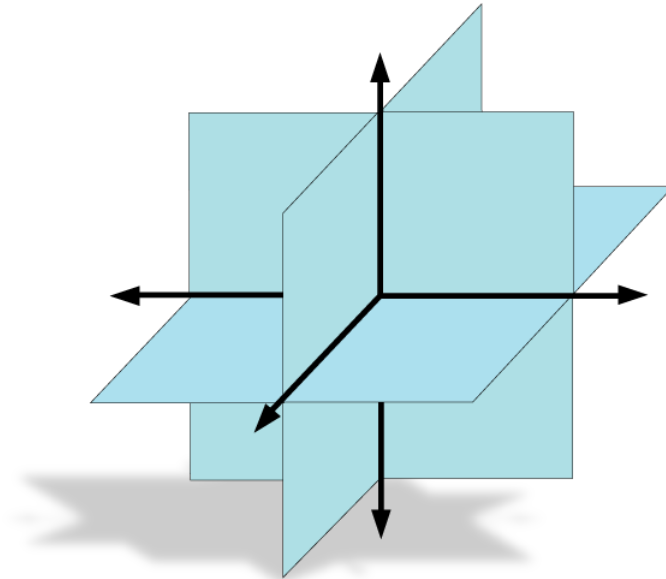

Core Theoretical Challenges

- How should we design the matrix Φ so that M is as small as possible?

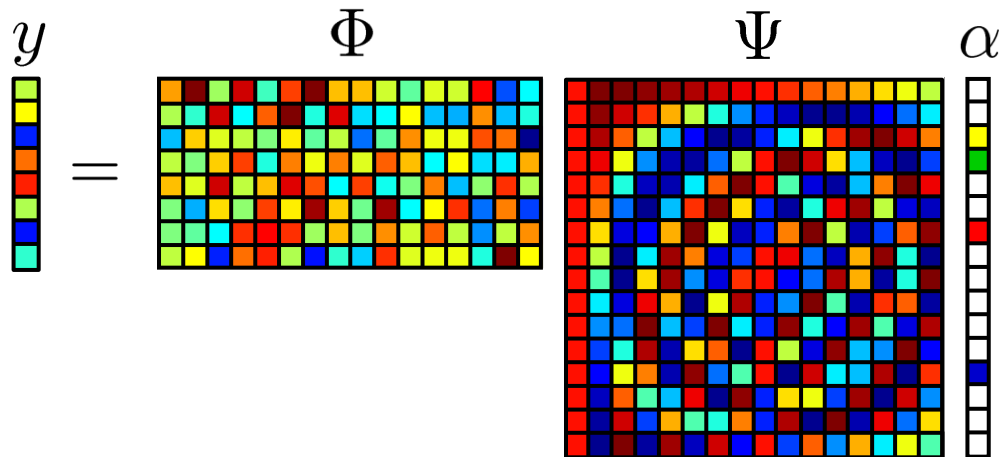

- How can we recover x from the measurements y ?

Outline

- Sensing matrices and real-world compressive sensors
 - (structured) randomness
 - tomography, cameras, ADCs, ...
- Sparse signal recovery
 - convex optimization
 - greedy algorithms
- Beyond recovery
 - compressive *signal processing*
- Beyond sparsity
 - parametric models, manifolds, low-rank matrices, ...

Sensing Matrix Design

Analog Sensing *is* Matrix Multiplication

If $x(t)$ is bandlimited,

$$y[m] = \langle \phi_m(t), x(t) \rangle = \sum_{n=-\infty}^{\infty} x[n] \langle \phi_m(t), \text{sinc}(t/T_s - n) \rangle$$

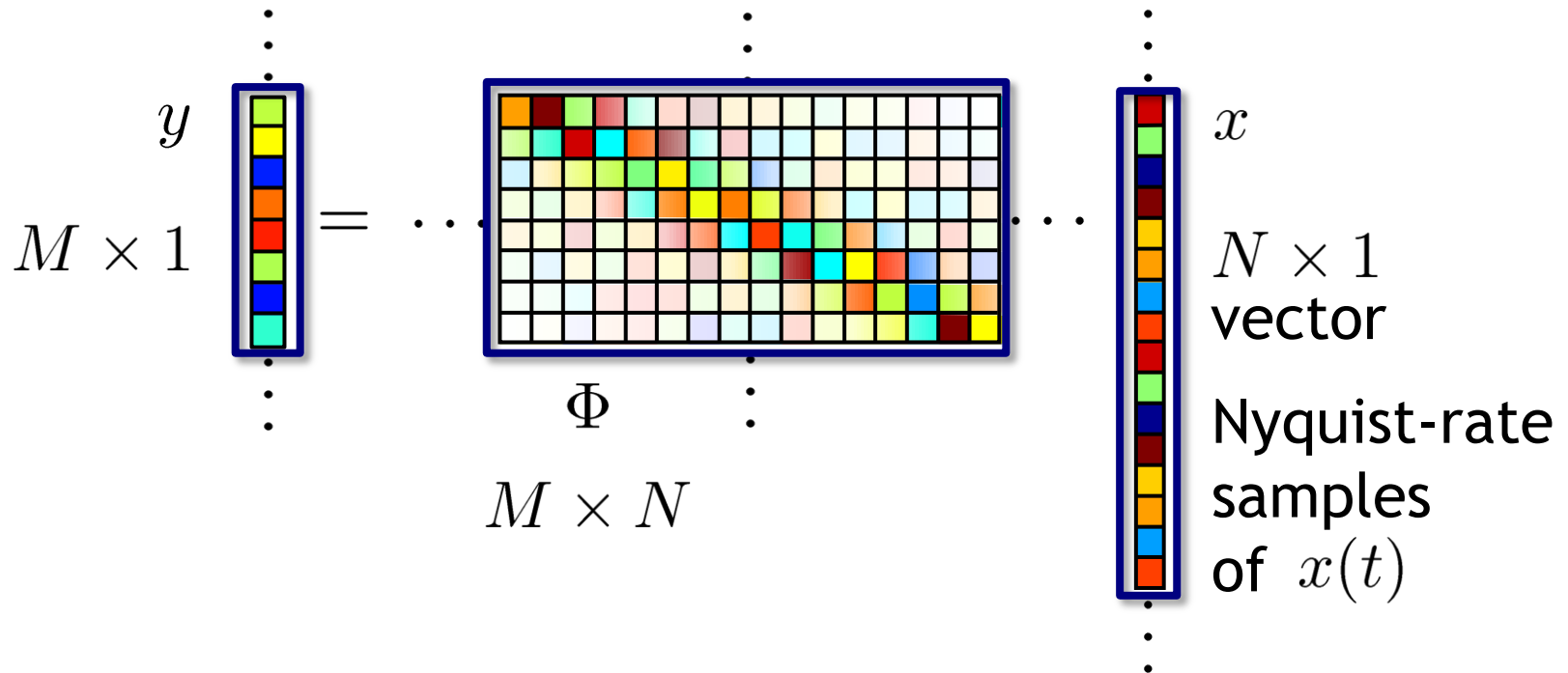

Restricted Isometry Property (RIP)

$$1 - \delta \leq \frac{\|\Phi x_1 - \Phi x_2\|_2^2}{\|x_1 - x_2\|_2^2} \leq 1 + \delta \quad \|x_1\|_0, \|x_2\|_0 \leq S$$

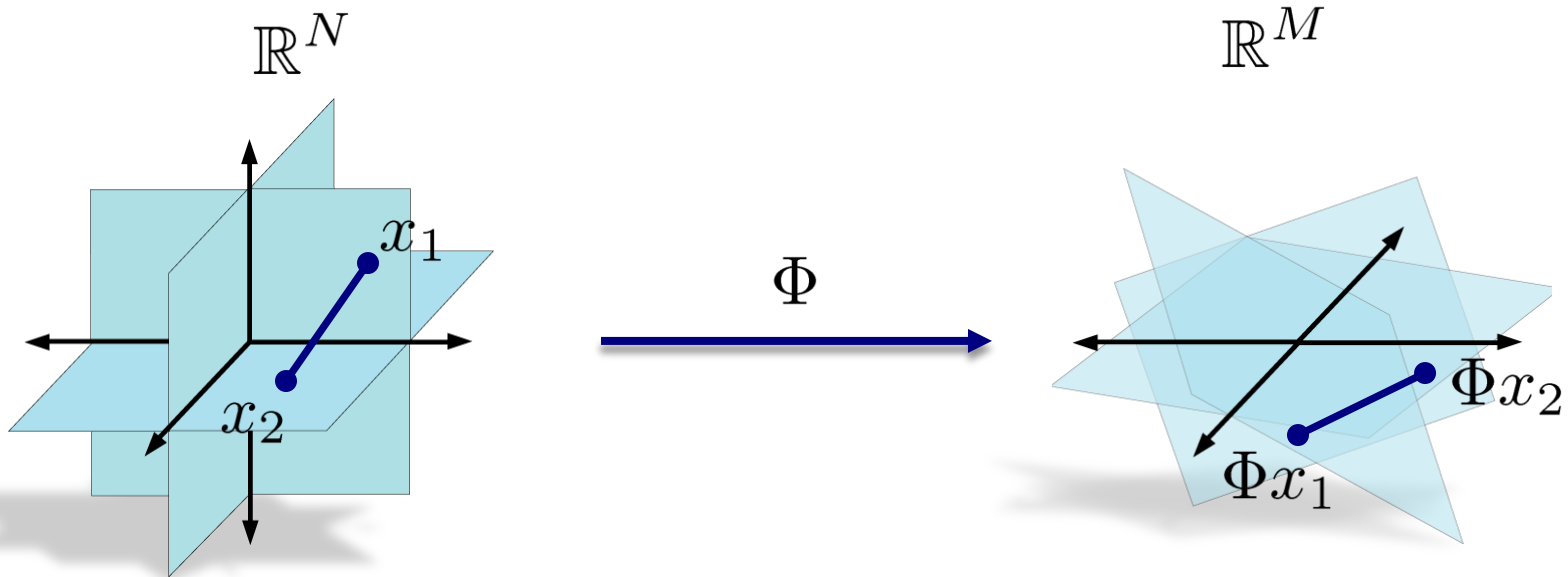

$$1 - \delta \leq \frac{\|\Phi x\|_2^2}{\|x\|_2^2} \leq 1 + \delta \quad \|x\|_0 \leq 2S$$

RIP and Stability

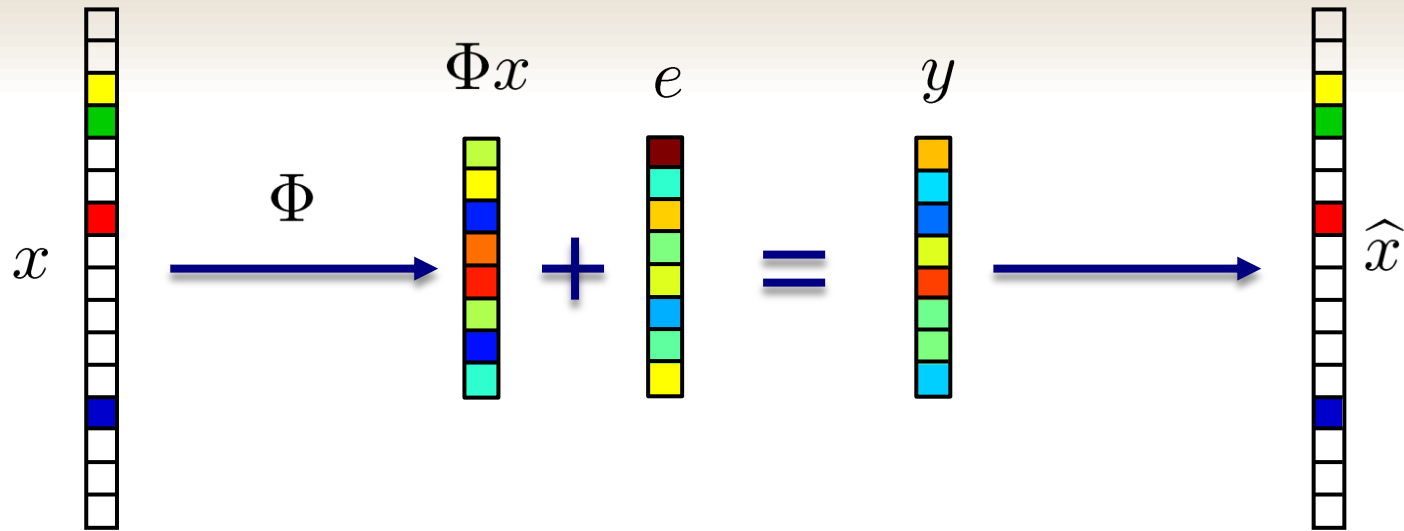

If we want to guarantee that

$$\|x - \hat{x}\|_2 \leq C\|e\|_2$$

then we must have

$$\frac{1}{C} \leq \frac{\|\Phi x\|_2^2}{\|x\|_2^2} \quad \|x\|_0 \leq 2S$$

Sub-Gaussian Distributions

- As a first example of a matrix Φ which satisfies the RIP, we will consider *random* constructions
- Sub-Gaussian random variable: $\mathbb{E} (e^{Xt}) \leq e^{c^2 t^2 / 2}$
 - Gaussian
 - Bernoulli/Rademacher (± 1)
 - any bounded distribution
- For any x , if the entries of Φ are sub-Gaussian, then there exists a δ such that with high probability

$$(1 - \delta) \|x\|_2^2 \leq \|\Phi x\|_2^2 \leq (1 + \delta) \|x\|_2^2$$

Johnson-Lindenstrauss Lemma

- Stable projection of a discrete set of P points

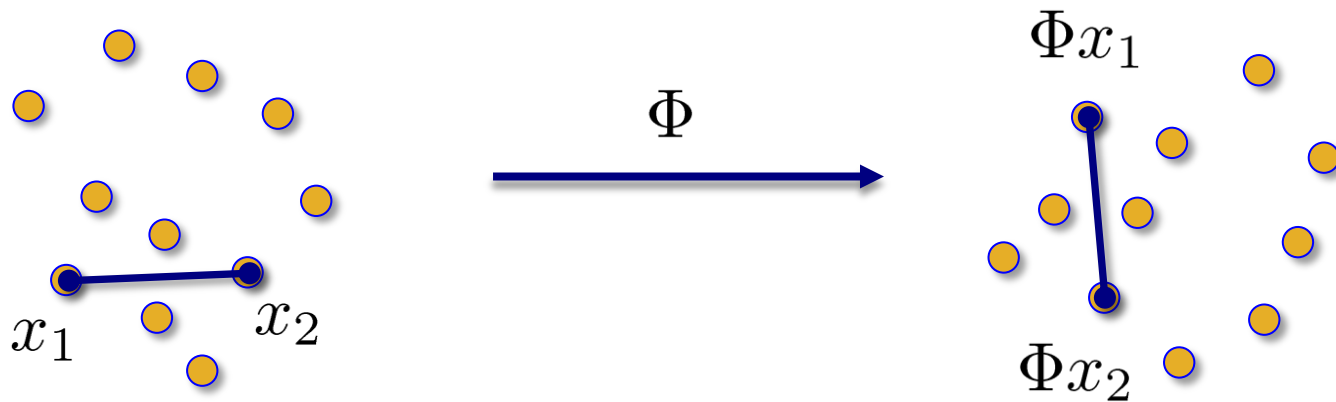

- Pick Φ at *random* using a sub-Gaussian distribution
- For any fixed x , $\|\Phi x\|_2$ concentrates around $\|x\|_2$ with (exponentially) high probability
- We preserve the length of all $O(P^2)$ difference vectors simultaneously if $M = O(\log P^2) = O(\log P)$.

JL Lemma Meets RIP

$$1 - \delta \leq \frac{\|\Phi x\|_2^2}{\|x\|_2^2} \leq 1 + \delta \quad \|x\|_0 \leq 2S$$

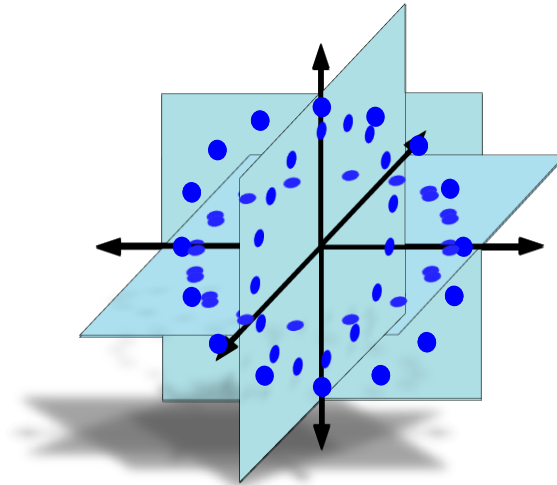

$$P = O((N/S)^S) \quad \longrightarrow \quad M = O(S \log(N/S))$$

RIP Matrix: Option 1

- Choose a *random matrix*
 - fill out the entries of Φ with i.i.d. samples from a sub-Gaussian distribution
 - project onto a “random subspace”

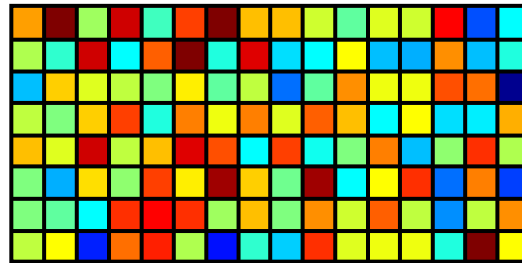

$$M = O(S \log(N/S)) \ll N$$

RIP Matrix: Option 2

- Random Fourier submatrix

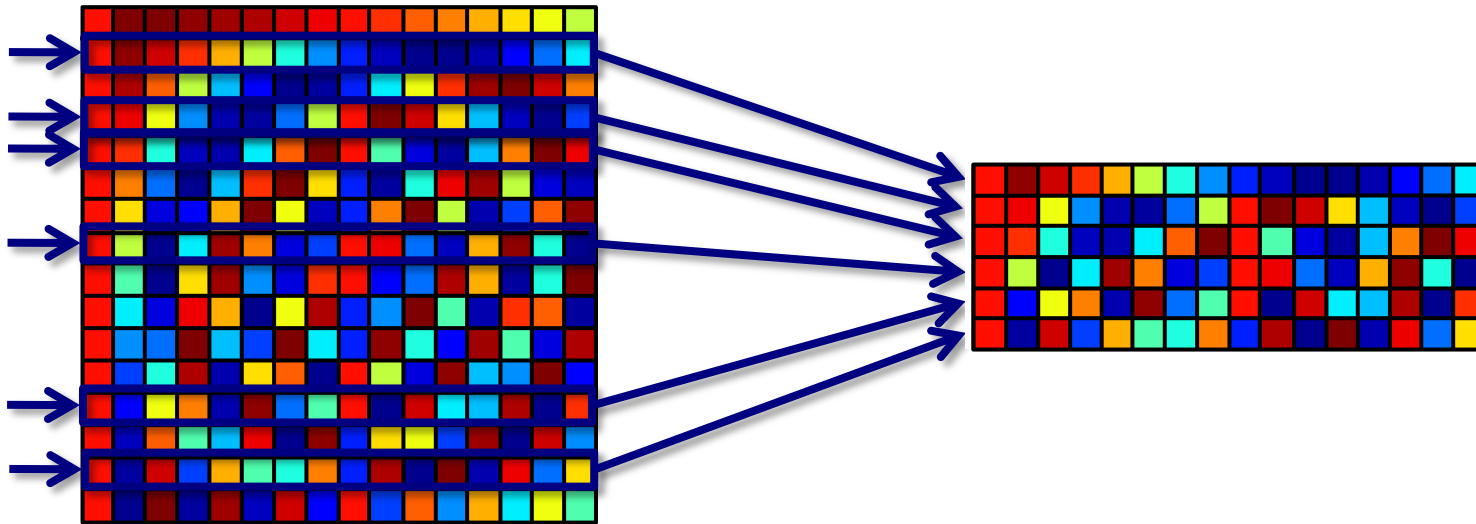

$$M = O(S \log^p(N/S)) \ll N$$

RIP Matrix: Option 3

“Fast JL Transform”

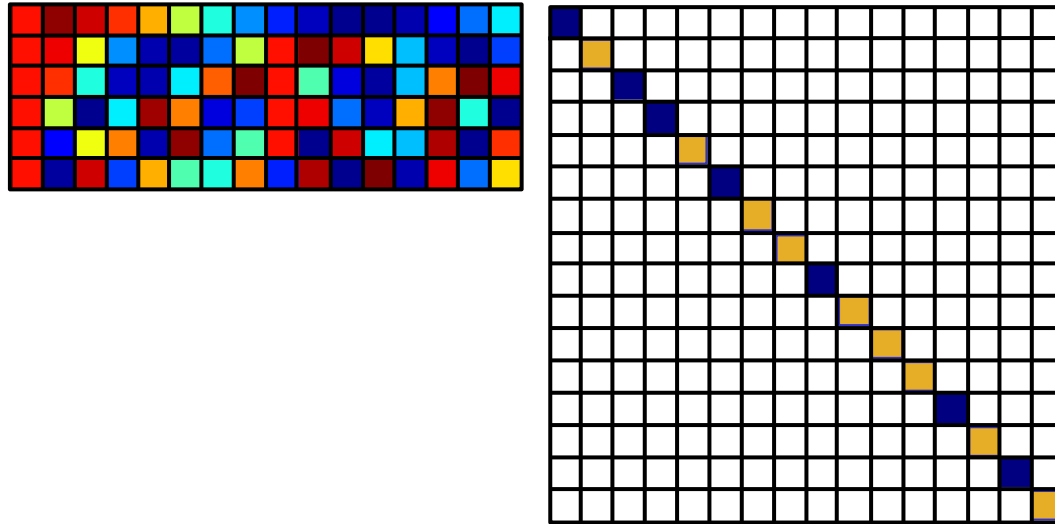

- By first multiplying by random signs, a random Fourier submatrix can be used for efficient JL embeddings
- If you multiply the columns of *any* RIP matrix by random signs, you get a JL embedding!

Hallmarks of Random Measurements

Stable

With high probability, Φ will preserve information, be robust to noise

Universal (Options 1 and 3)

Φ will work with **any** fixed orthonormal basis (w.h.p.)

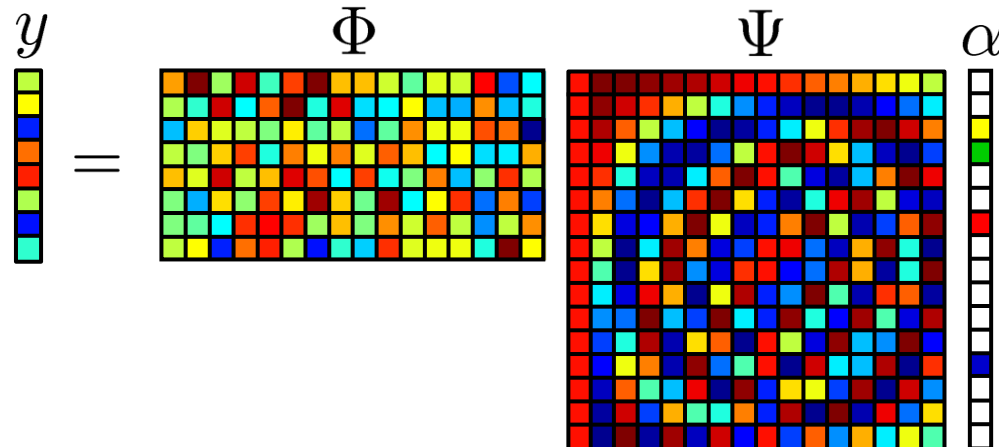

Democratic

Each measurement has “equal weight”

Compressive Sensors in Practice

Tomography in the Abstract

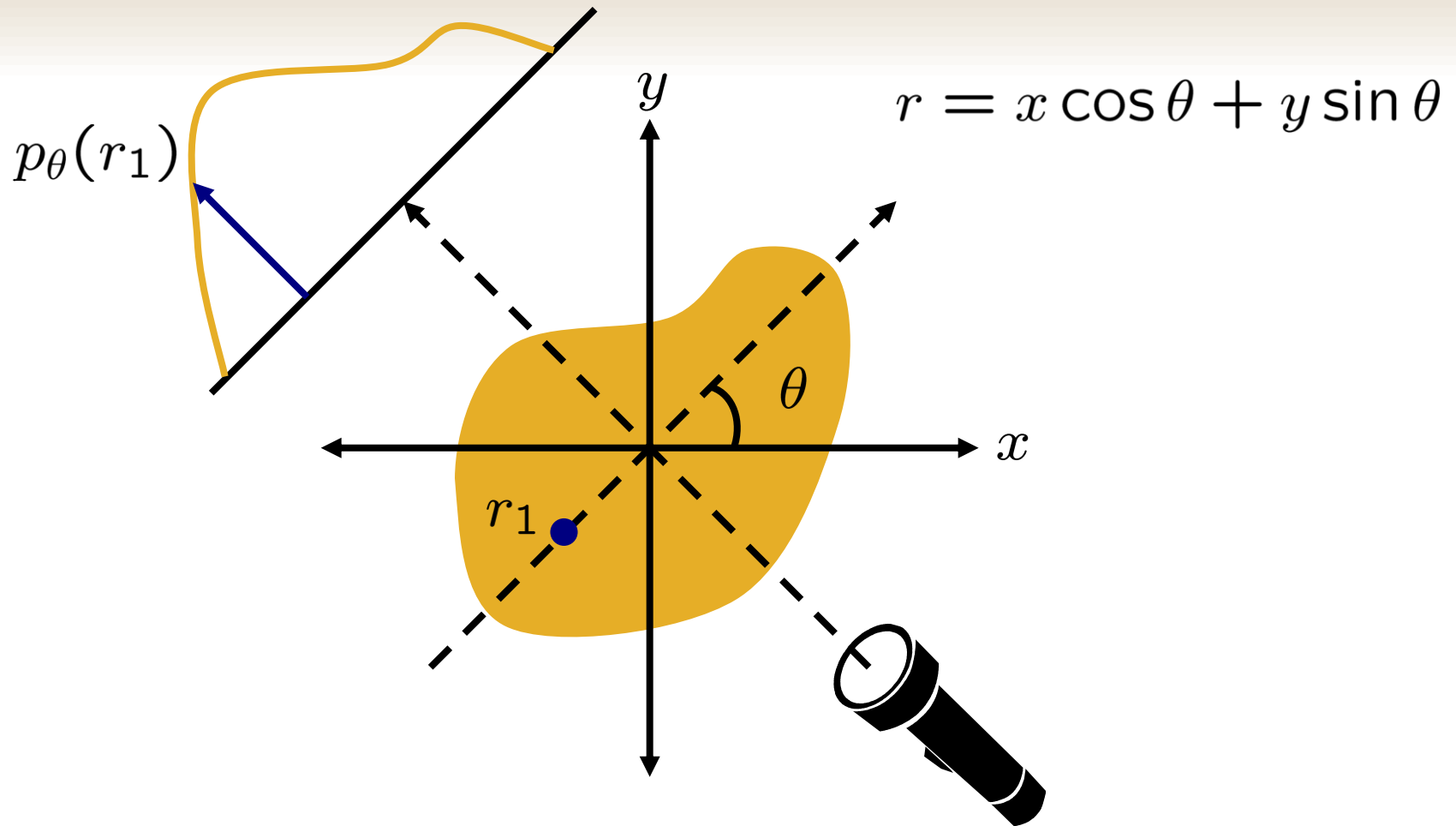

$$p_\theta(r) = \int \int f(x, y) \delta(x \cos \theta + y \sin \theta - r) dx dy$$

Fourier-Domain Interpretation

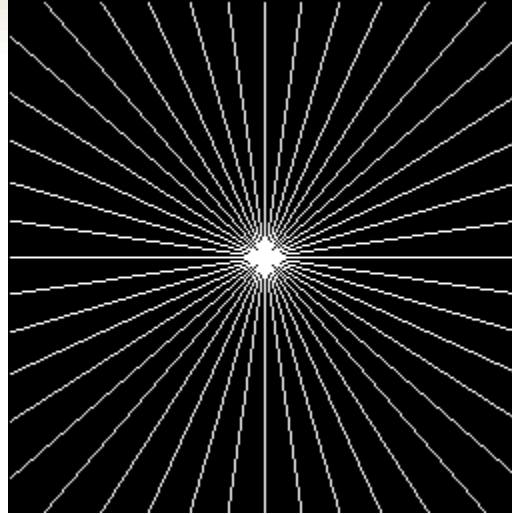

- Each projection gives us a “slice” of the 2D Fourier transform of the original image
- Similar ideas in MRI
- Traditional solution: Collect lots (and lots) of slices

Why CS?

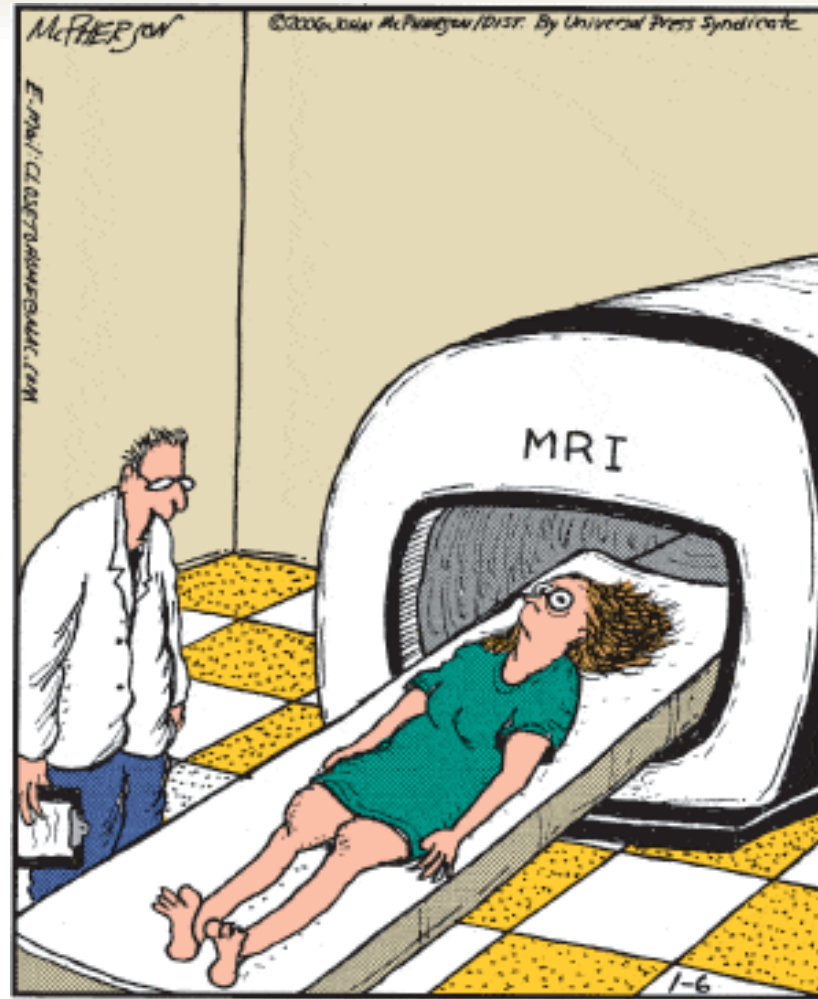

“OK, Mrs. Dunn. We’ll slide you in there, scan your brain, and see if we can find out why you’ve been having these spells of claustrophobia.”

CS for MRI Reconstruction

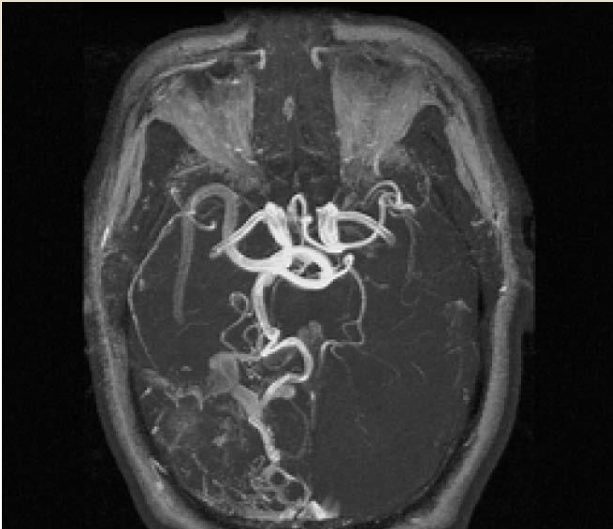

256x256 MRA



Backproj., 29.00dB

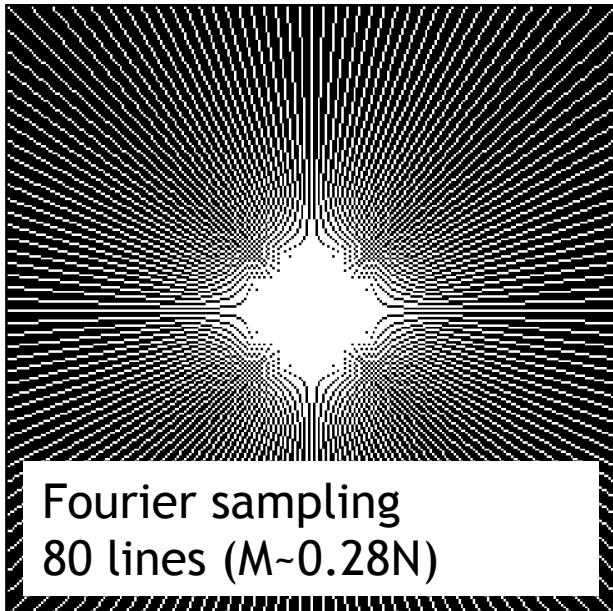

Fourier sampling
80 lines ($M \sim 0.28N$)

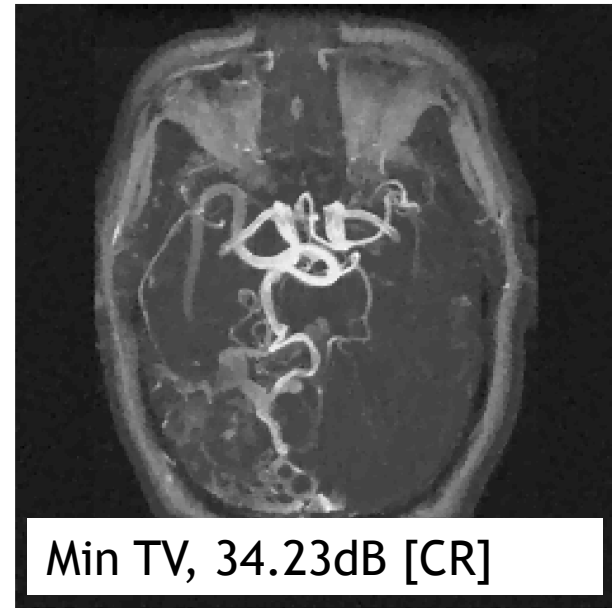

Min TV, 34.23dB [CR]

Pediatric MRI



Traditional MRI



CS MRI

4-8 x faster!

“Single-Pixel Camera”

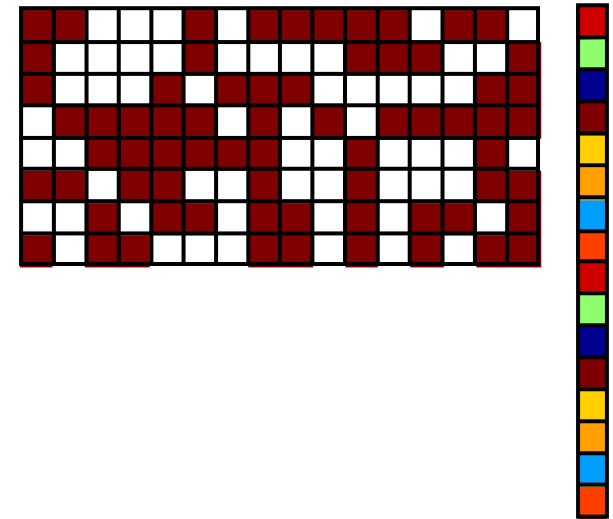

$$y[m] = \sum_{n \in I_m} x[n]$$

$$x[n] = \int \int_{\text{pixel } n} x(t_1, t_2) dt_1 dt_2$$

TI Digital Micromirror Device

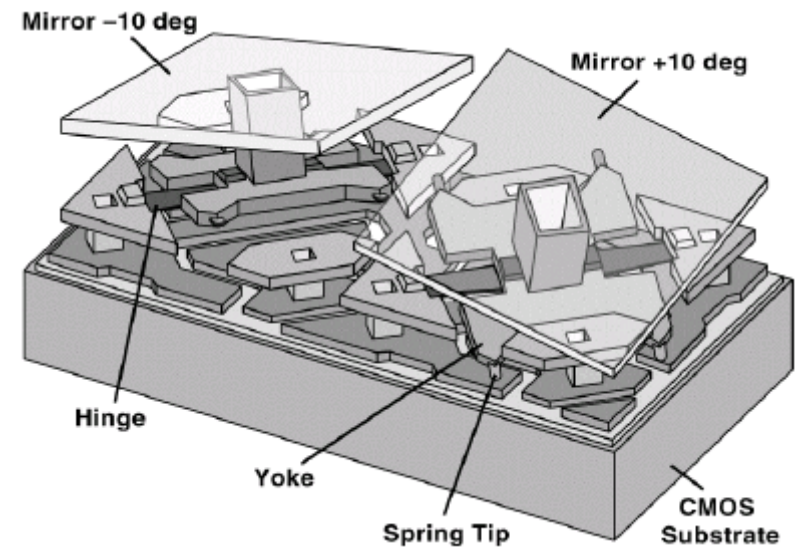
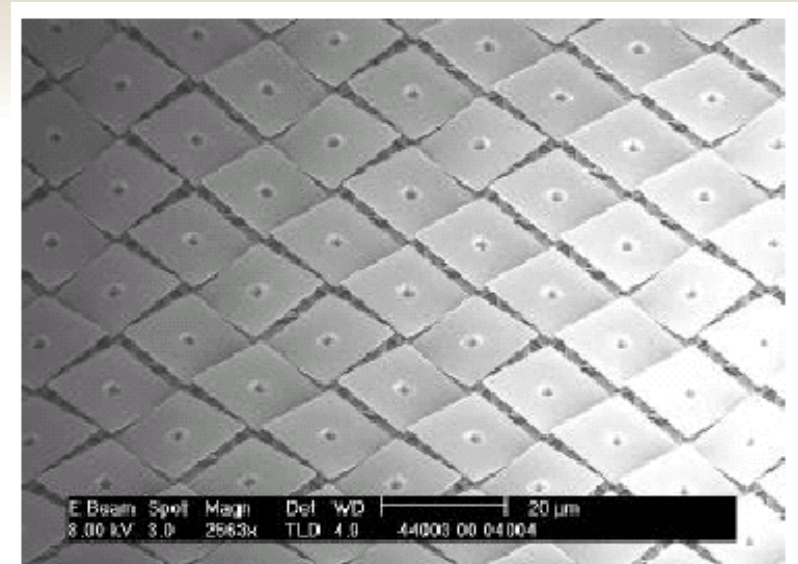
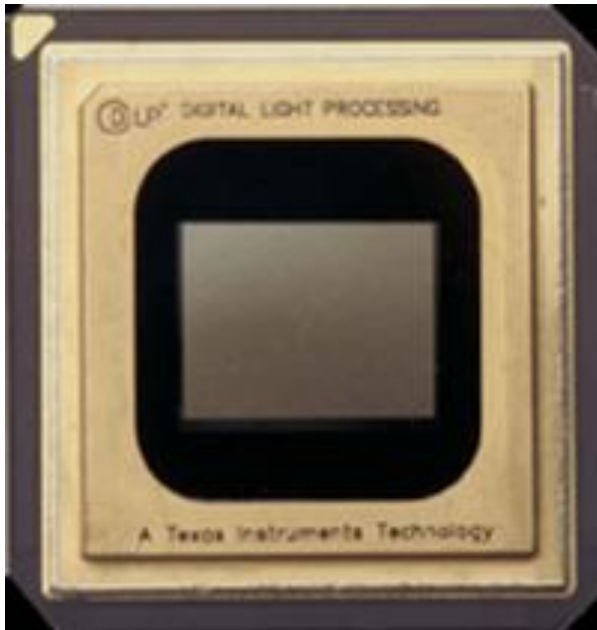

Compressive ADCs

Build high-rate ADC for signals with sparse spectra

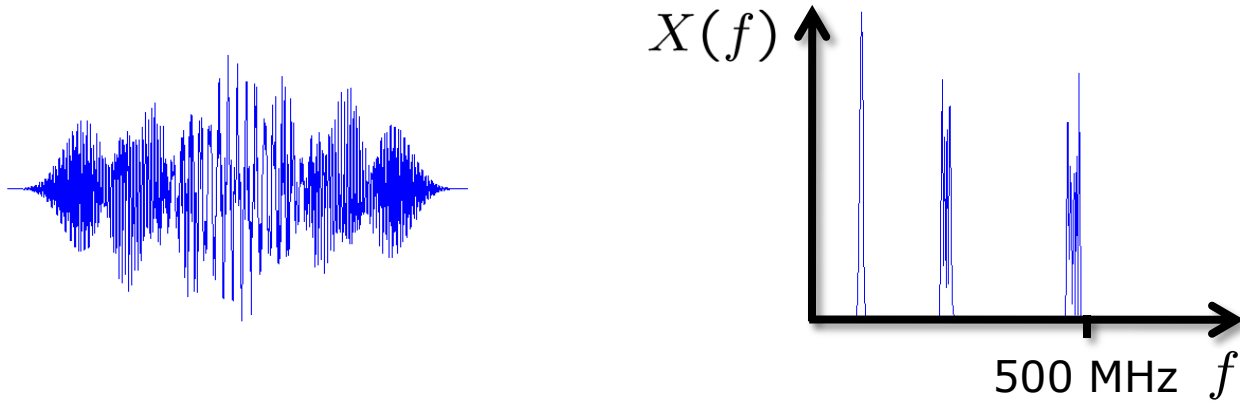

Compressive ADCs

Build high-rate ADC for signals with sparse spectra

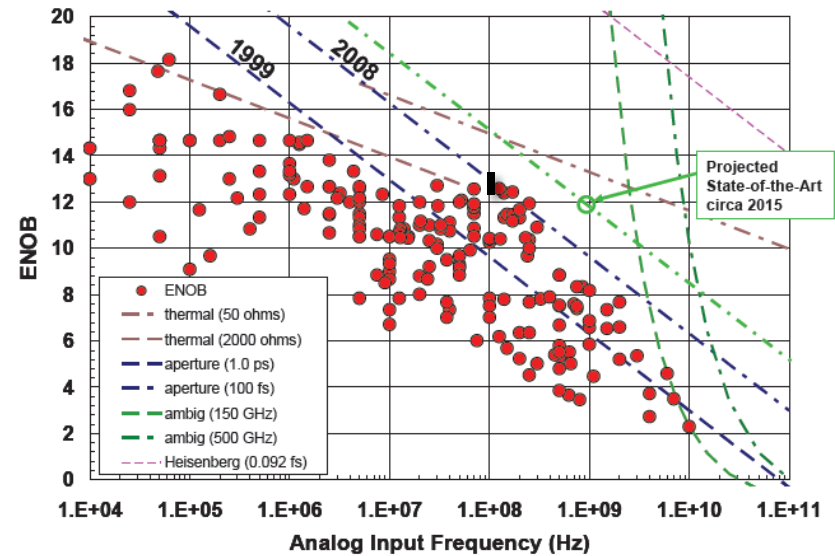
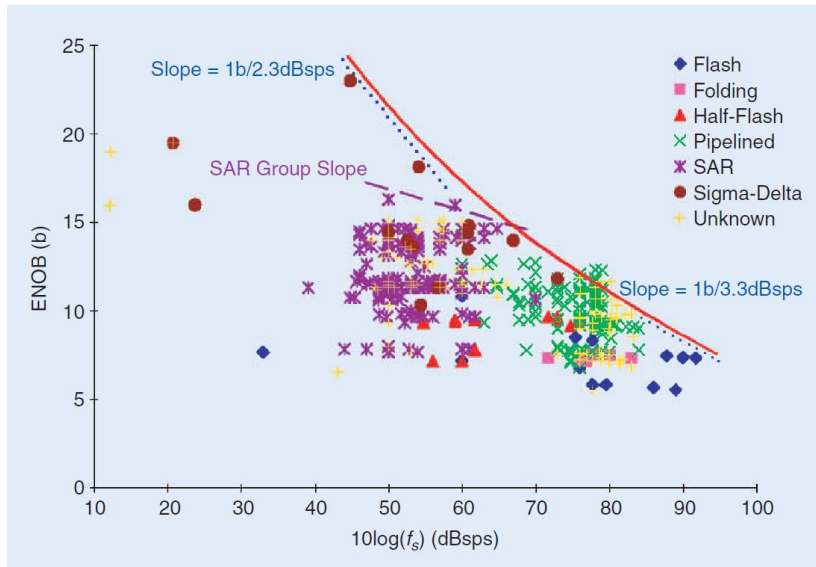

Compressive ADC Approaches

- Random sampling
 - long history of related ideas/techniques
 - random sampling for Fourier-sparse data equivalent to obtaining random Fourier coefficients for sparse data
- Random demodulation
 - CDMA-like spreading followed by low-rate uniform sampling
 - modulated wideband converter
 - compressive multiplexor, polyphase random demodulator
- Both approaches are specifically tailored for Fourier-sparse signals

Random Demodulator

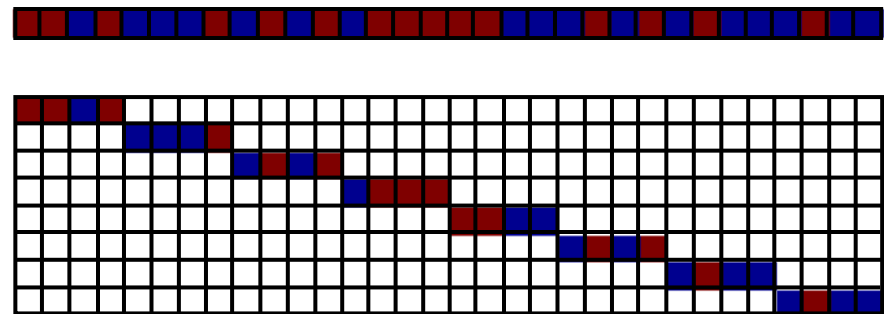
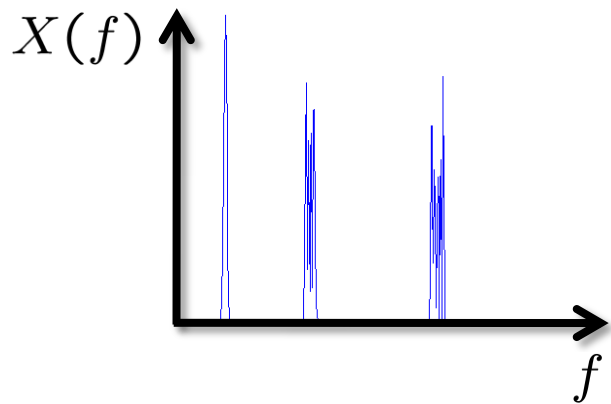
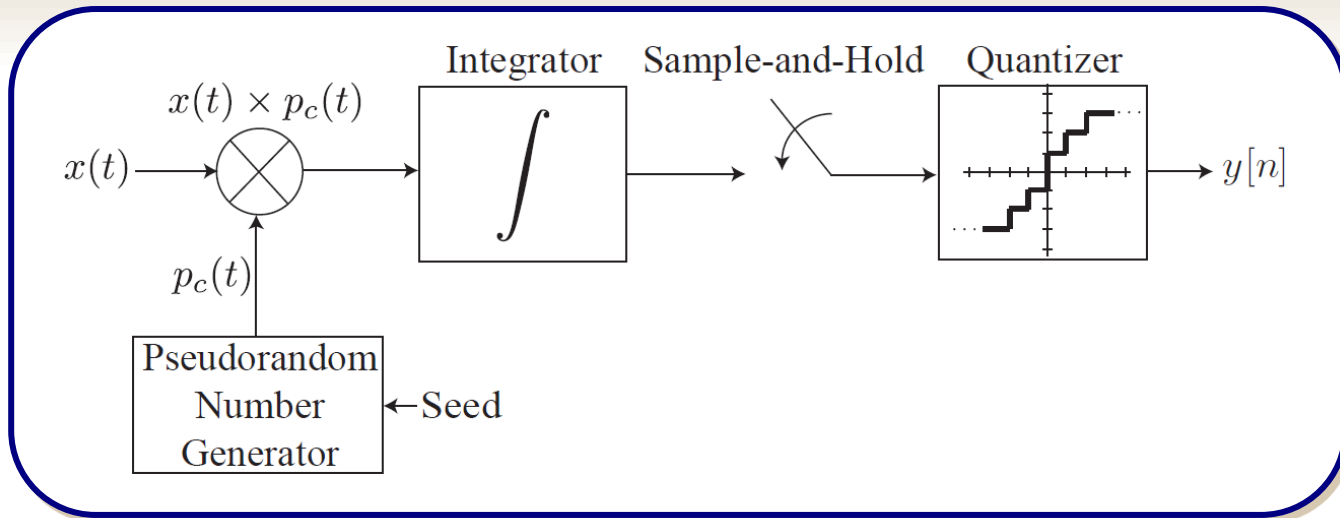

Random Demodulator

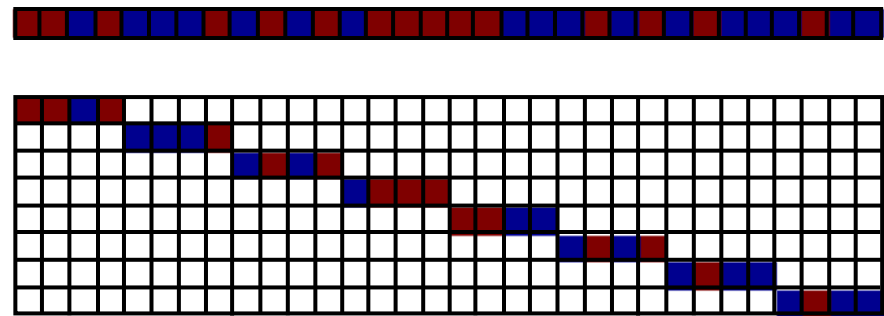
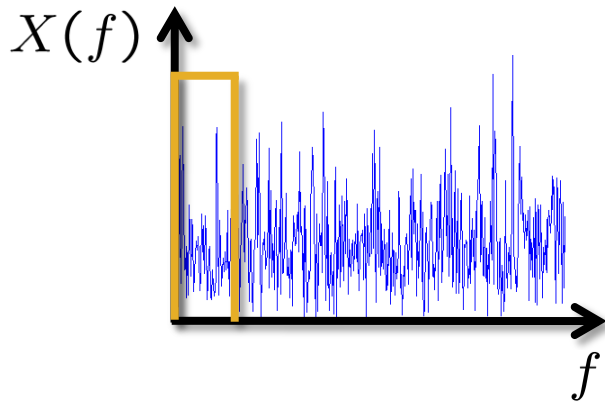
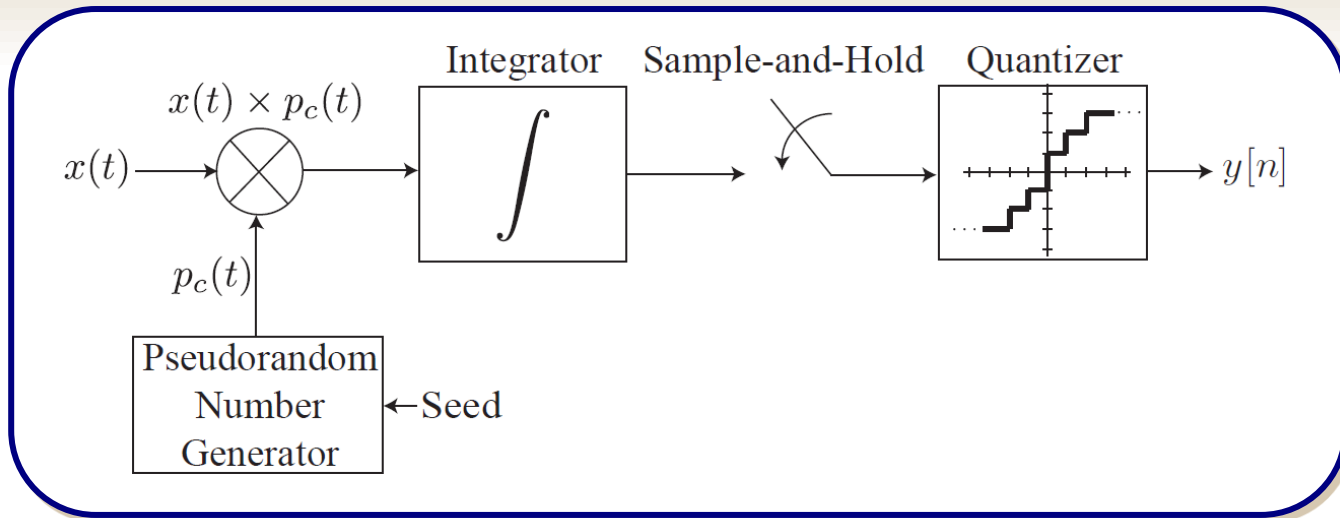

Empirical Results

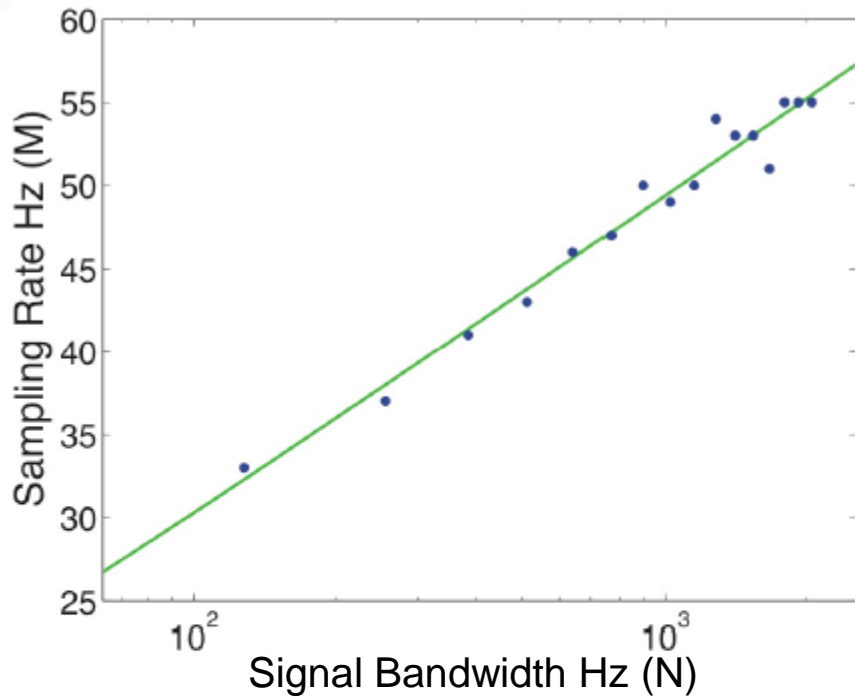

$$1.69S \log(N/S + 1) + 4.51$$

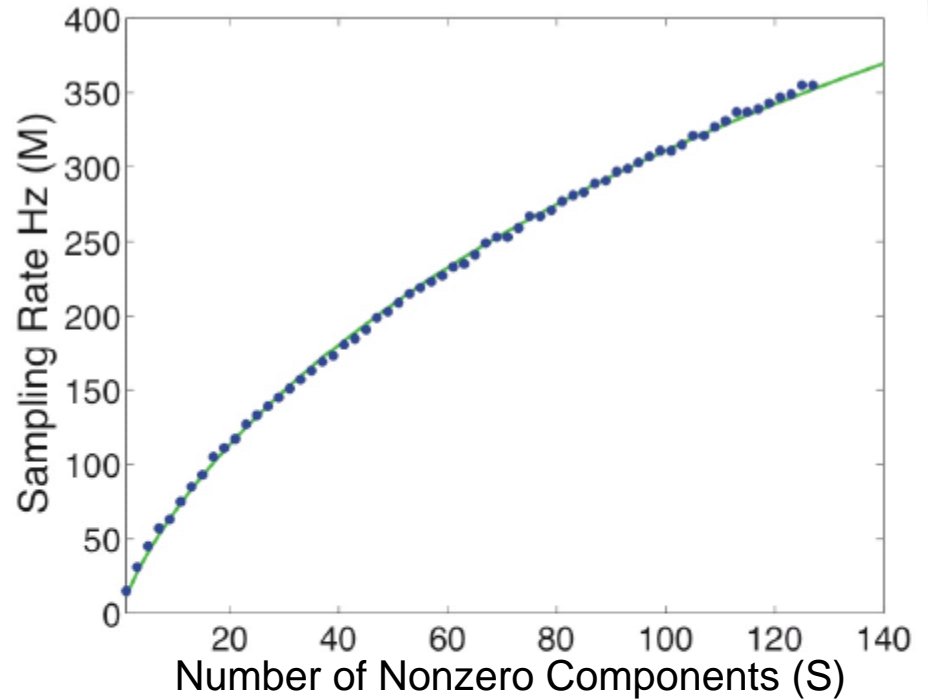

$$1.71S \log(N/S + 1) + 1$$

$$M \approx 1.7S \log(N/S + 1)$$

Example: Frequency Hopper

Nyquist rate sampling

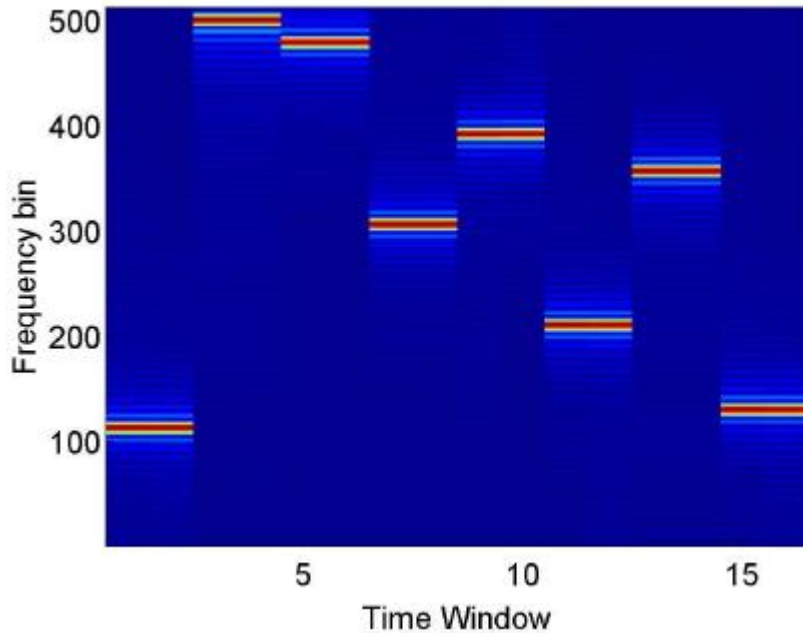

20x sub-Nyquist sampling

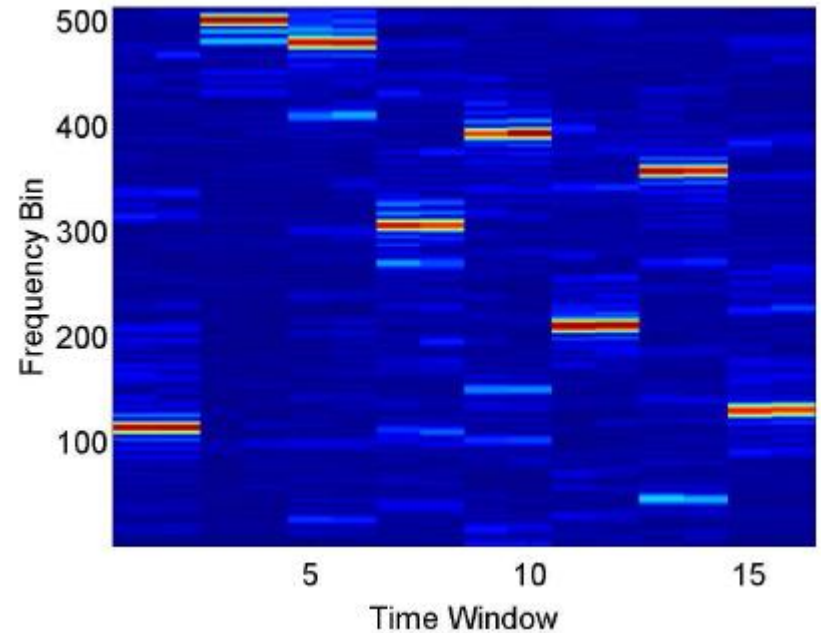

Compressive Multiplexor

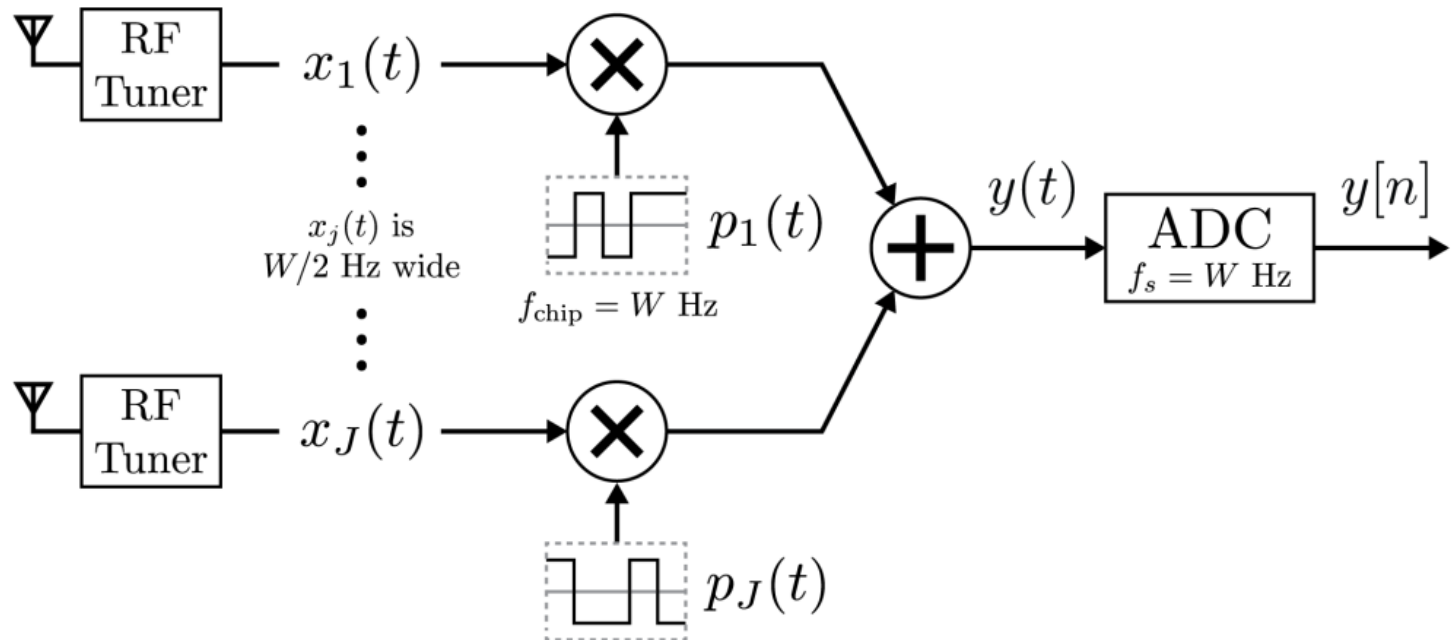

Compressive Multiplexor in Hardware

- Boils down to:
 - 1 LFSR
 - J switches
 - $2J$ resistors
 - 2 op amps
 - 1 low-rate ADC

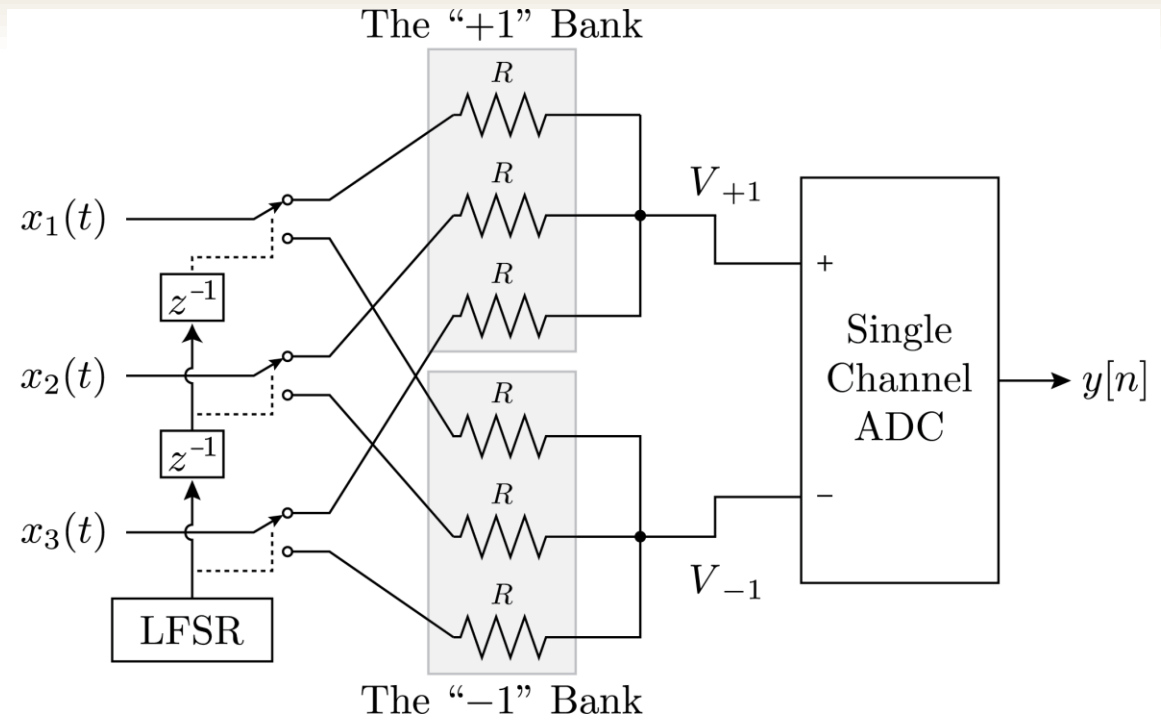
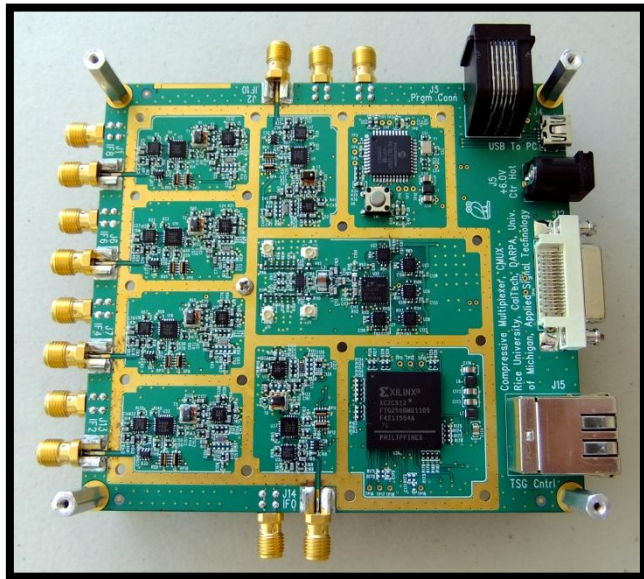

1.1mm x 1.1mm ASIC on its way!

Compressive Sensors Wrap-up

- CS is built on a theory of *random measurements*
 - Gaussian, Bernoulli, random Fourier, fast JLT
 - stable, universal, democratic
- Randomness can often be built into real-world sensors
 - tomography
 - cameras
 - compressive ADCs
 - microscopy
 - astronomy
 - sensor networks
 - DNA microarrays and biosensing
 - radar
 - ...

Sparse Signal Recovery

Sparse Signal Recovery

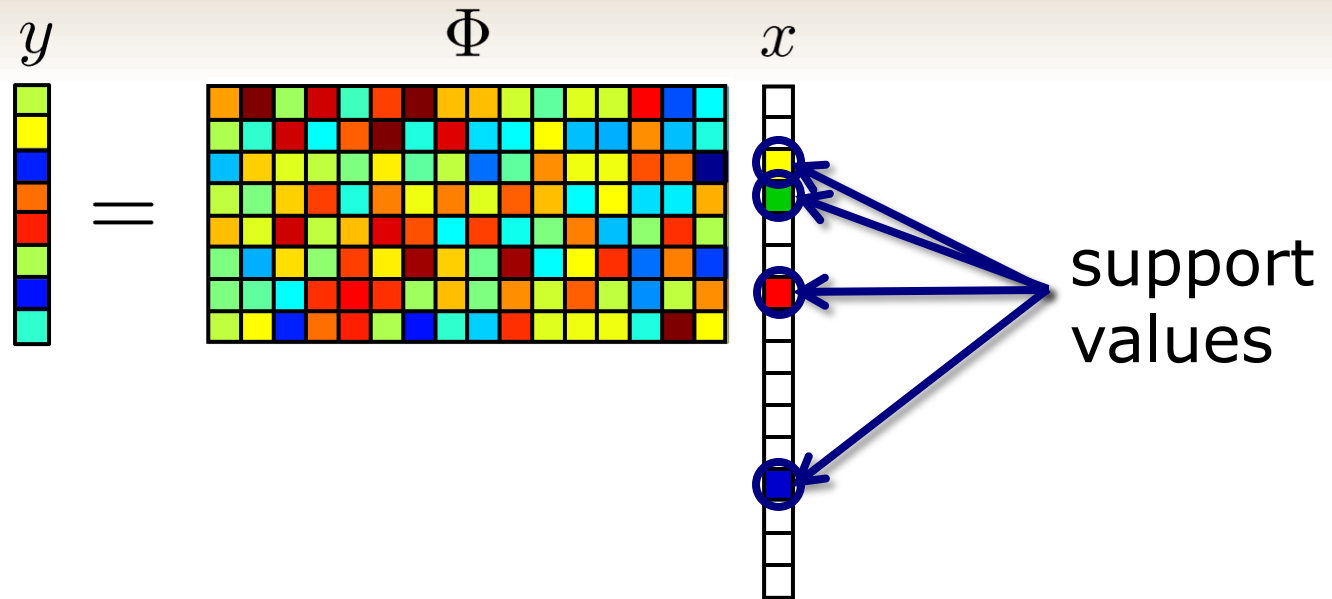

- Optimization / ℓ_1 -minimization
- Greedy algorithms
 - matching pursuit
 - orthogonal matching pursuit (OMP)
 - Stagewise OMP (StOMP), regularized OMP (ROMP)
 - CoSaMP, Subspace Pursuit, IHT, ...

Sparse Recovery: Noiseless Case

given $y = \Phi x$
find x

- ℓ_0 -minimization: $\hat{x} = \arg \min_{x \in \mathbb{R}^N} \|x\|_0$ ← *nonconvex*
s.t. $y = \Phi x$ *NP-Hard*
- ℓ_1 -minimization: $\hat{x} = \arg \min_{x \in \mathbb{R}^N} \|x\|_1$ ← *convex*
s.t. $y = \Phi x$ *linear program*
- If Φ satisfies the RIP, then ℓ_0 and ℓ_1 are equivalent!

Why ℓ_1 -Minimization Works

$$\begin{aligned}\hat{x} &= \arg \min_{x \in \mathbb{R}^N} \|x\|_1 \\ \text{s.t. } & y = \Phi x\end{aligned}$$

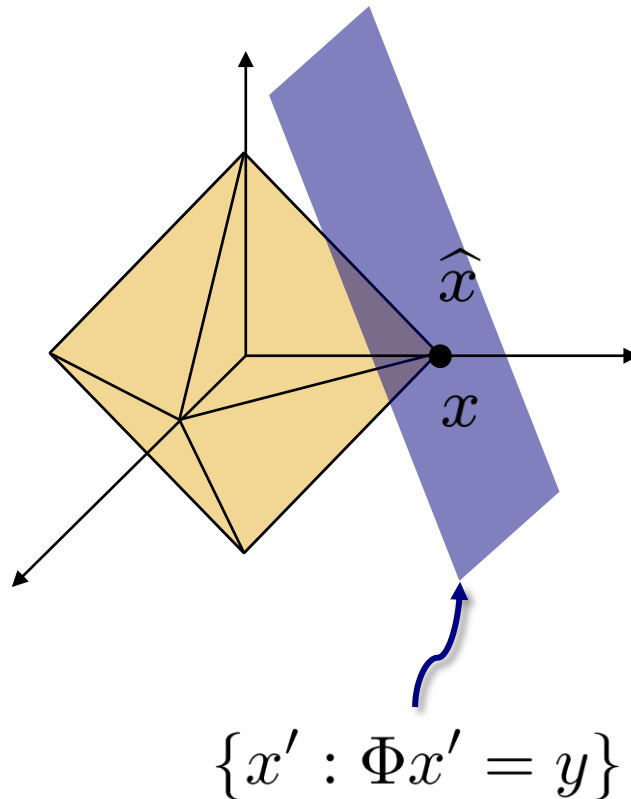

Sparse Recovery: Noisy Case

Suppose we observe $y = \Phi x + e$, where $\|e\|_2 \leq \epsilon$

$$\begin{aligned} \hat{x} &= \arg \min_{x \in \mathbb{R}^N} \|x\|_1 \\ \text{s.t.} \quad &\|y - \Phi x\|_2 \leq \epsilon \end{aligned}$$

$$\|\hat{x} - x\|_2 \leq C_0 \epsilon$$

Similar approaches can handle Gaussian noise added to either the signal or the measurements

Sparse Recovery: Non-sparse Signals

In practice, x may not be exactly S -sparse

$$\begin{aligned}\hat{x} &= \arg \min_{x \in \mathbb{R}^N} \|x\|_1 \\ \text{s.t. } & \|y - \Phi x\|_2 \leq \epsilon\end{aligned}$$

$$\|\hat{x} - x\|_2 \leq C_0 \epsilon + C_1 \frac{\|x - x_S\|_1}{\sqrt{S}}$$

Greedy Algorithms: Key Idea

If we can determine $\Lambda = \text{supp}(x)$, then the problem becomes *over-determined*.

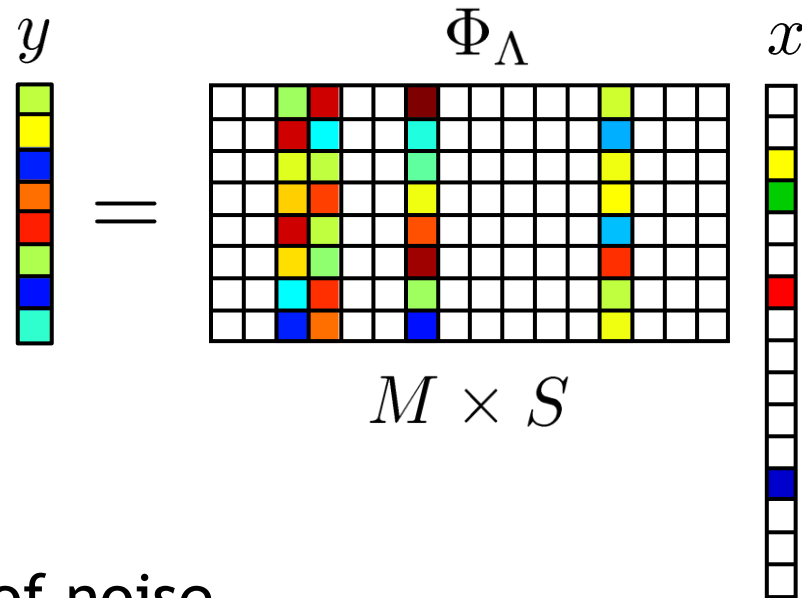

In the absence of noise,

$$\begin{aligned}\Phi_\Lambda^\dagger y &= (\Phi_\Lambda^T \Phi_\Lambda)^{-1} \Phi_\Lambda^T y \\ &= (\Phi_\Lambda^T \Phi_\Lambda)^{-1} \Phi_\Lambda^T \Phi_\Lambda x \\ &= x\end{aligned}$$

Matching Pursuit

Select one index at a time using a simple *proxy* for x

$$p = \Phi^T y$$

$$j^* = \arg \max_j |p_j|$$

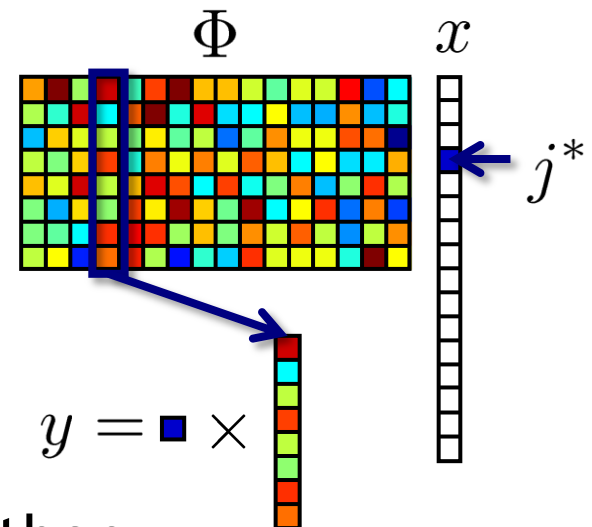

If Φ satisfies the RIP of order $\|u \pm v\|_0$, then

$$|\langle \Phi u, \Phi v \rangle - \langle u, v \rangle| \leq \delta \|u\|_2 \|v\|_2$$

Set $u = x$ and $v = e_j$

$$|p_j - x_j| \leq \delta \|x\|_2$$

Matching Pursuit

Obtain initial estimate of x

$$x^{(1)} = p_{j^*} e_{j^*}$$

Update proxy and iterate

$$p = \Phi^T (y - \Phi x^{(j-1)})$$

$$j^* = \arg \max_j |p_j|$$

$$x^{(j)} = x^{(j-1)} + p_{j^*} e_{j^*}$$

Iterative Hard Thresholding (IHT)

$$x^{(j)} = H_S \left(x^{(j-1)} + \underbrace{\mu \Phi^T (y - \Phi x^{(j-1)})}_{\text{proxy vector}} \right)$$

step size

hard thresholding

proxy vector

RIP guarantees convergence and accurate/stable recovery

Orthogonal Matching Pursuit

Replace $x^{(j)} = x^{(j-1)} + p_{j^*} e_{j^*}$ with

$$x^{(j)} = \arg \min_x \|y - \Phi_\Lambda x\|_2$$

where Λ is the set of indices selected up to iteration j

$$j^* = \arg \max_j |\langle Py, P\Phi_j \rangle|$$

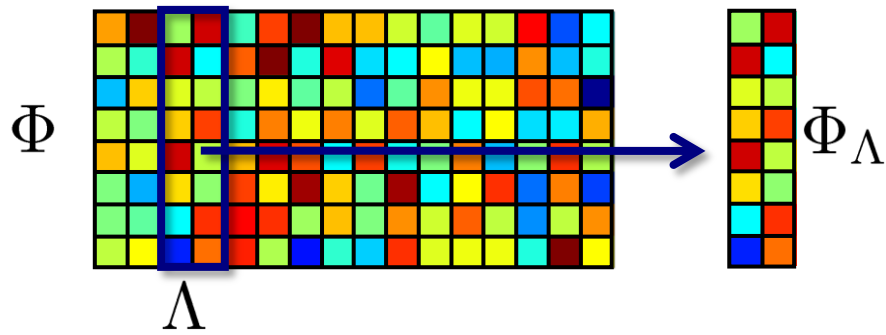

$$P = I - \underbrace{\Phi_\Lambda \Phi_\Lambda^\dagger}_{\text{Projection onto } \mathcal{R}(\Phi_\Lambda)}$$

Projection onto $\mathcal{R}(\Phi_\Lambda)$

$$P\Phi_\Lambda = 0 \quad \longrightarrow \quad P\Phi x = P\Phi x_{\Lambda^c}$$

Interference Cancellation

If Φ satisfies the RIP of order S , then

$$\left(1 - \frac{\delta}{1 - \delta}\right) \|x\|_2^2 \leq \|P\Phi x\|_2^2 \leq (1 + \delta) \|x\|_2^2$$

for all x with $\|x\|_0 \leq S - |\Lambda|$ and $\text{supp}(x) \cap \Lambda = \emptyset$.

$$\longrightarrow |\langle Py, P\Phi_j \rangle - x_j| \leq \frac{\delta}{1 - \delta} \|x_{\Lambda^c}\|_2$$

Orthogonal Matching Pursuit

Suppose x is S -sparse and $y = \Phi x$.
If Φ satisfies the RIP of order $S + 1$ with constant $\delta < 1/3\sqrt{S}$, then the j^* identified at each iteration will be a nonzero entry of x .

➡ Exact recovery after S iterations

Extensions of OMP

- StOMP, ROMP
 - select many indices in each iteration
 - picking indices for which p_j is “comparable” leads to increased stability and robustness
- CoSaMP, Subspace Pursuit, ...
 - allow indices to be discarded
 - strongest guarantees, comparable to ℓ_1 -minimization

$$\|x - x^{(j+1)}\|_2 \leq \frac{1}{2} \|x - x^{(j)}\|_2 + C \|e\|_2$$

$$\|x - x^{(j+1)}\|_2 \leq 2^{-j} \|x - x^{(j)}\|_2 + 2C \|e\|_2$$

Beyond Recovery

Compressive Signal Processing

Random measurements are *information scalable*

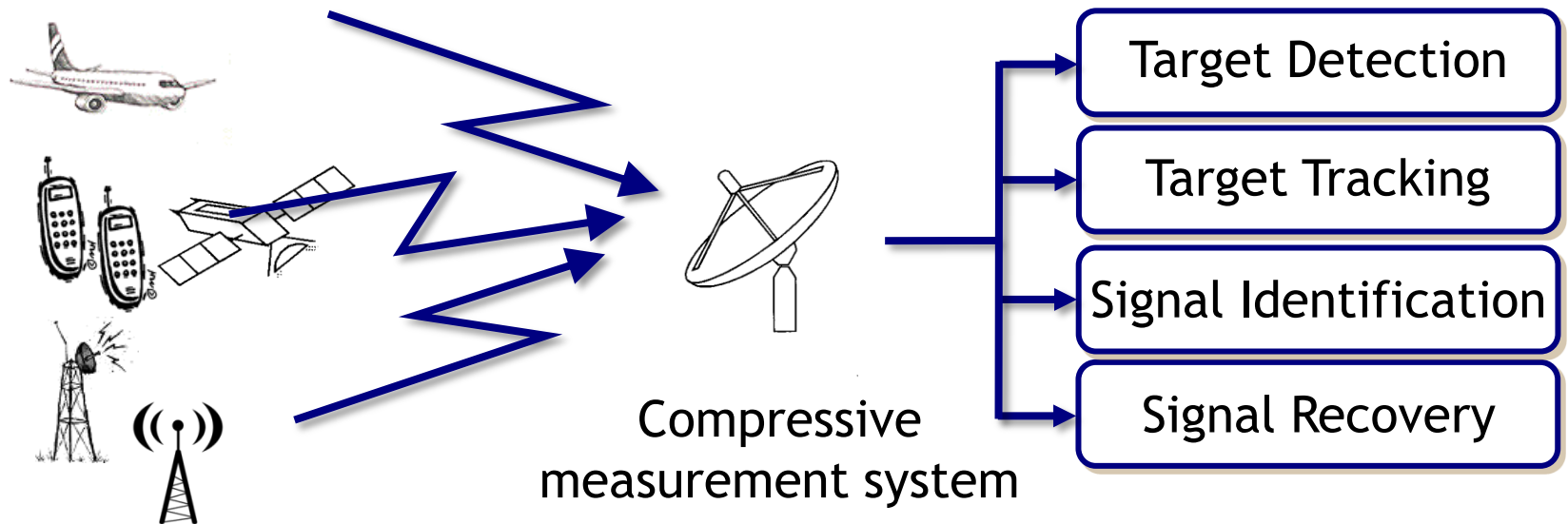

When and how can we directly solve signal processing problems directly from compressive measurements?

Compressive Radio Receivers

Example Scenario

- 300 MHz bandwidth
- 5 FM signals (12 kHz)
- TV station interference
- Acquire compressive measurements at 30 MHz (20 x undersampled)

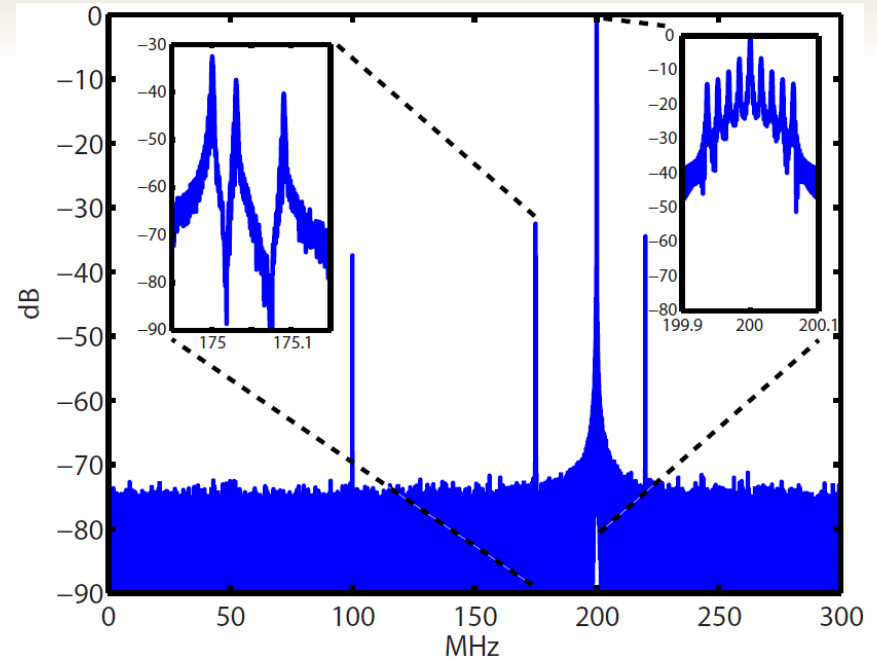

We must simultaneously solve several problems

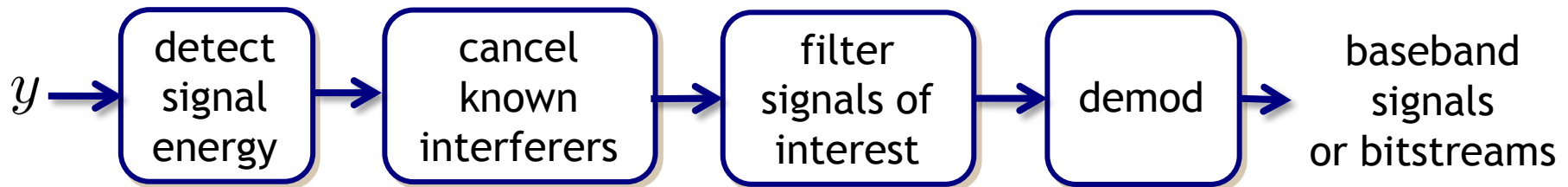

Energy Detection

We need to identify where in frequency the important signals are located

Compressive Estimation: correlate with projected tones

$$\hat{F}(k) = |\langle \Phi \cos(2\pi f_k t), y \rangle|$$

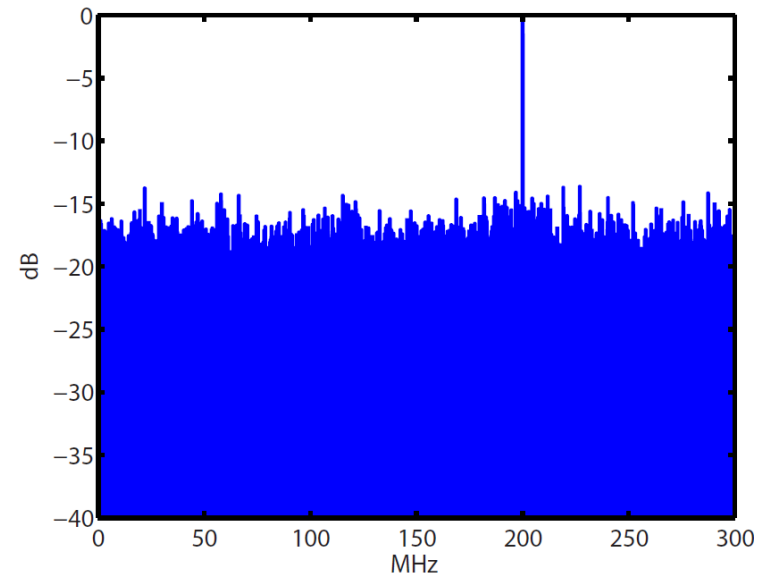
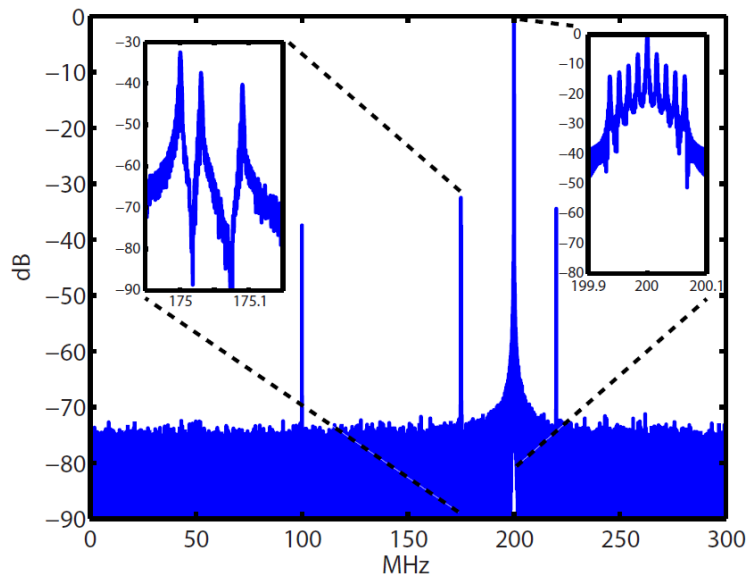

Filtering

If we have multiple signals, must be able to filter to isolate and cancel interference

$$P = I - \Phi \Psi_I (\Phi \Psi_I)^\dagger$$

Ψ_I : Discrete prolate spheroidal sequences

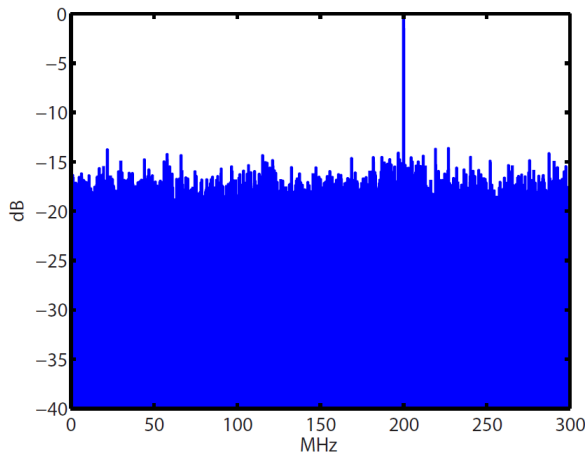

original

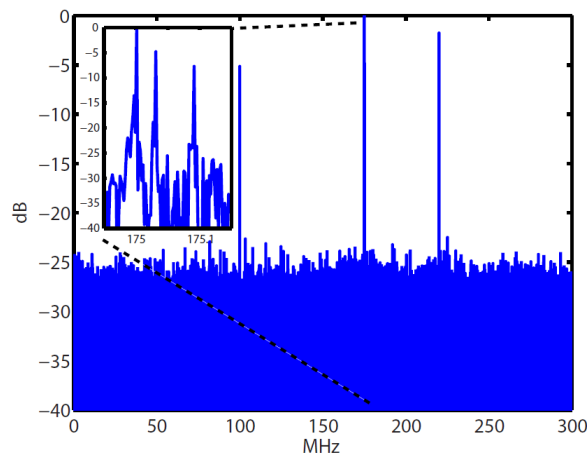

after interference
cancellation

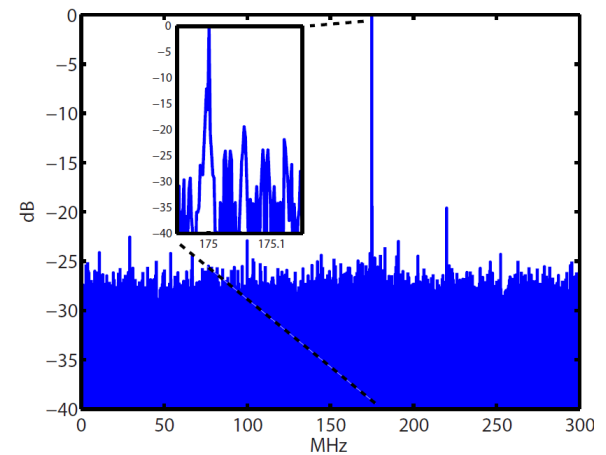

after isolation
filtering

Unsynchronized Demodulation

We can use a phase-locked-loop (PLL) to track deviations in frequency by directly operating on compressive measurements

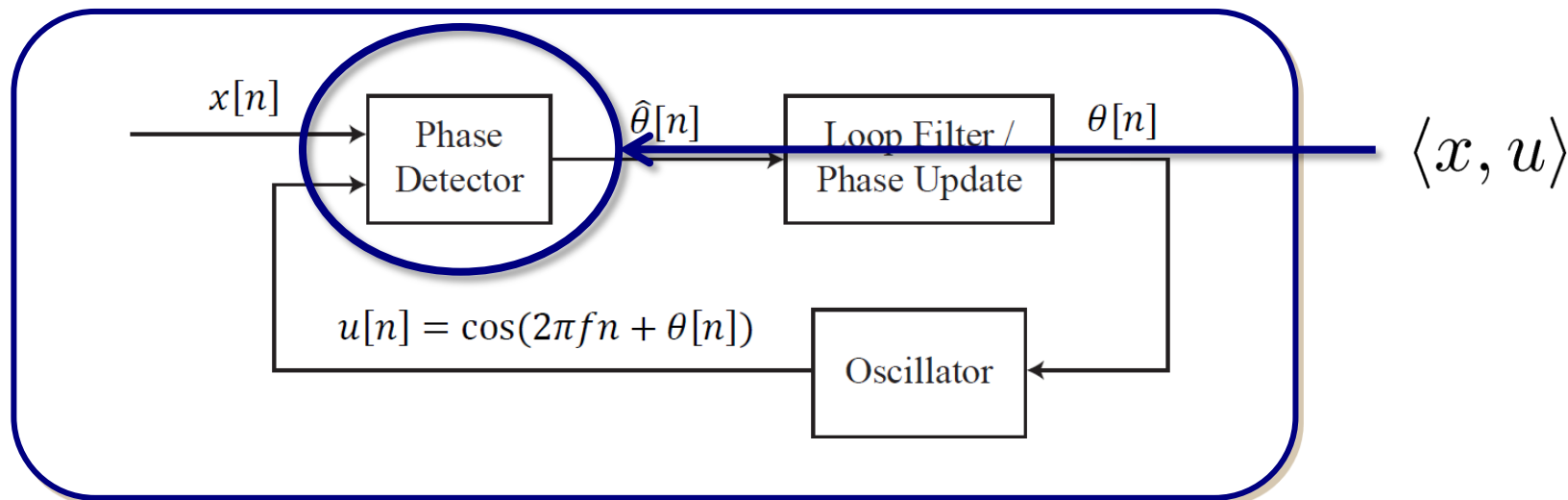

We can directly demodulate signals from compressive measurements *without recovery*

Unsynchronized Demodulation

We can use a phase-locked-loop (PLL) to track deviations in frequency by directly operating on compressive measurements

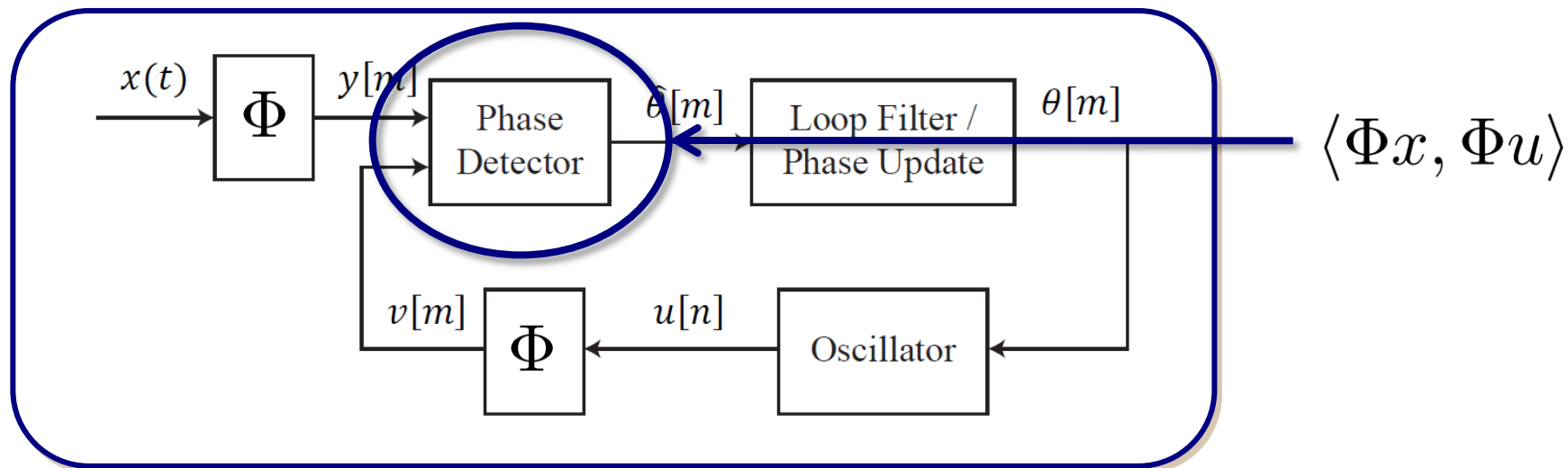

We can directly demodulate signals from compressive measurements *without recovery*

Compressive Domain Demodulation

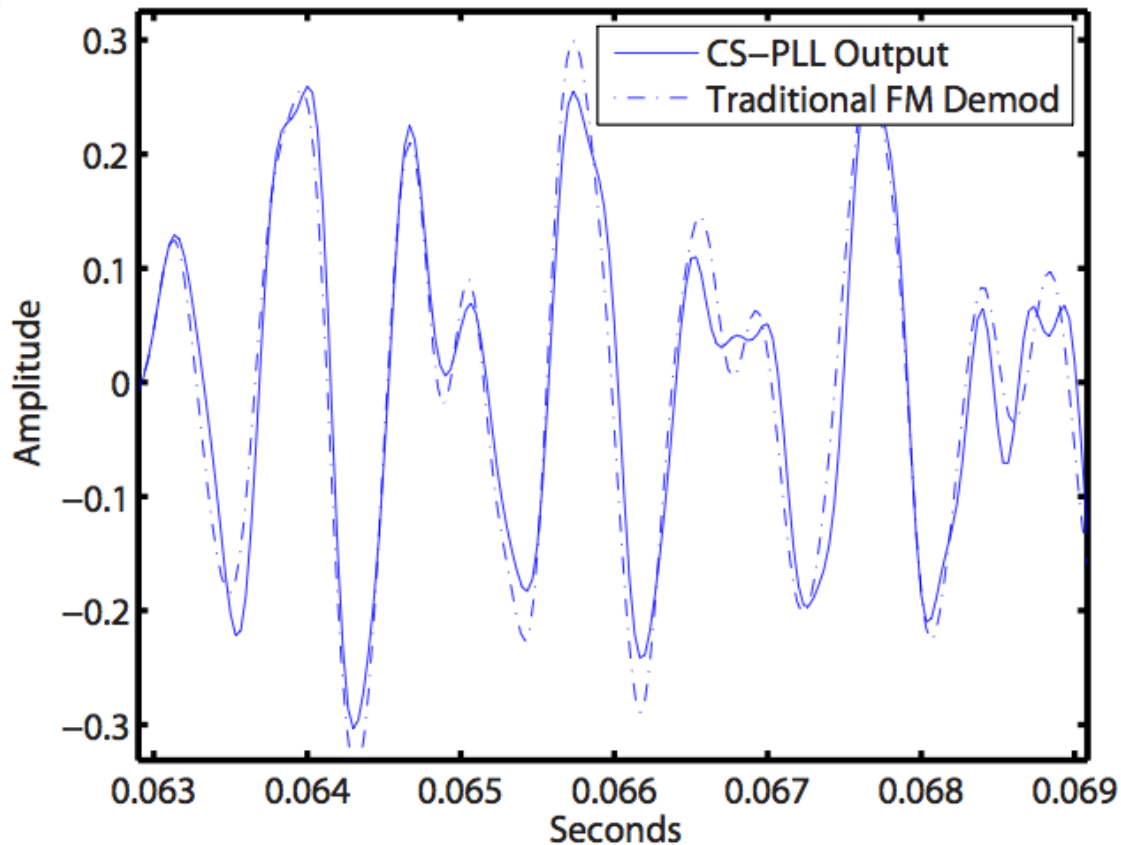

CS-PLL with
20x undersampling

Beyond Sparsity

Beyond Sparsity

- Not all signal models fit neatly into the “sparse” setting
- The concept of “dimension” has many incarnations
 - “degrees of freedom”
 - constraints
 - parameterizations
 - signal families
- How can we exploit these low-dimensional models?
- I will focus primarily on just a few of these
 - *structured* sparsity, finite-rate-of-innovation, manifolds, low-rank matrices

Structured Sparsity

- Sparse signal model captures *simplistic primary structure*
- Modern compression/processing algorithms capture *richer secondary coefficient structure*

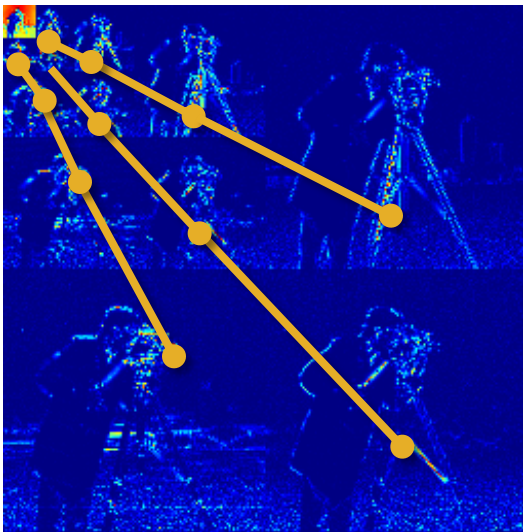

wavelets:
natural images

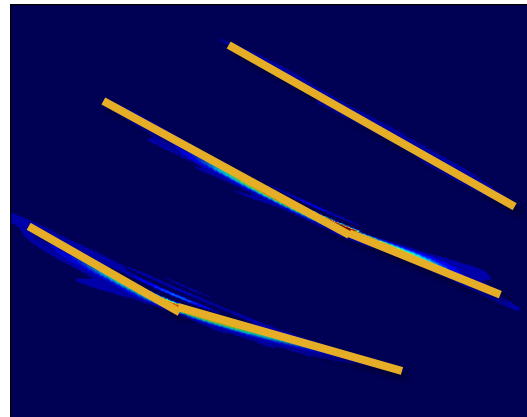

Gabor atoms:
chirps/tones

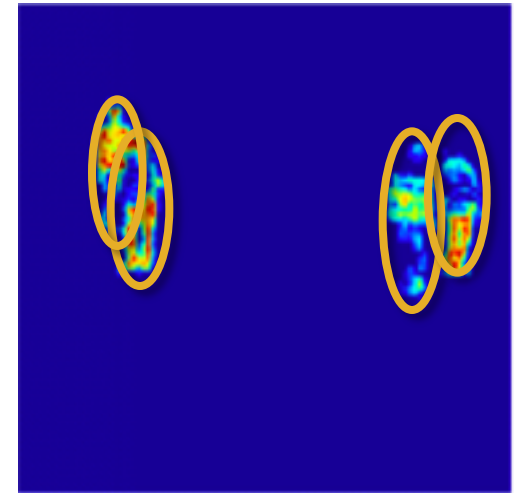

pixels:
background subtracted
images

Sparse Signals

Traditional sparse models allow all possible S -dimensional subspaces

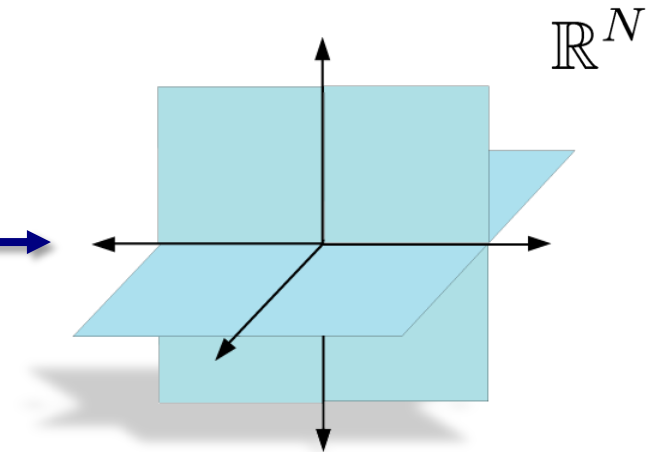
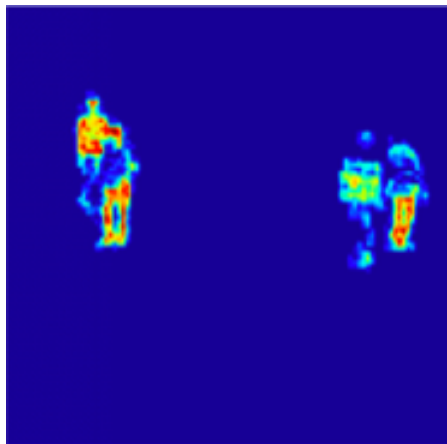
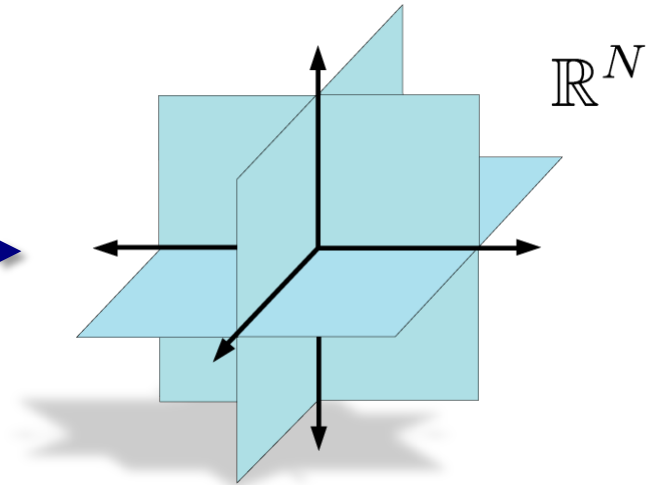
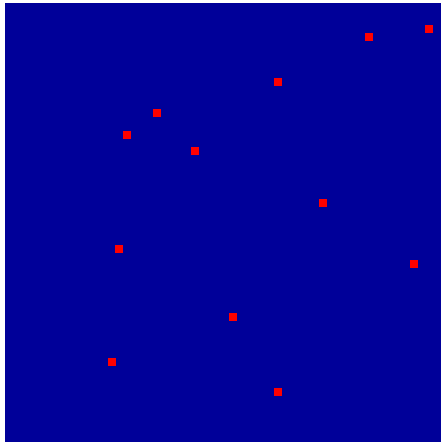

Wavelets and Tree-Sparse Signals

Model: S nonzero coefficients lie on a connected tree

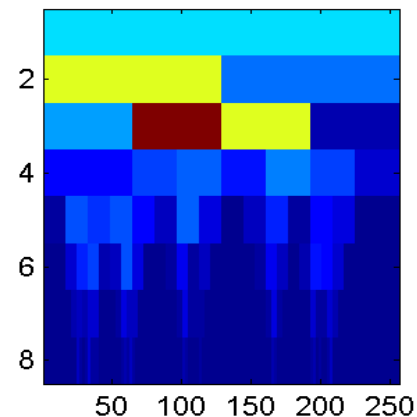
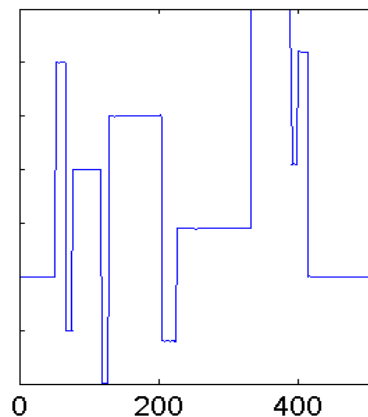
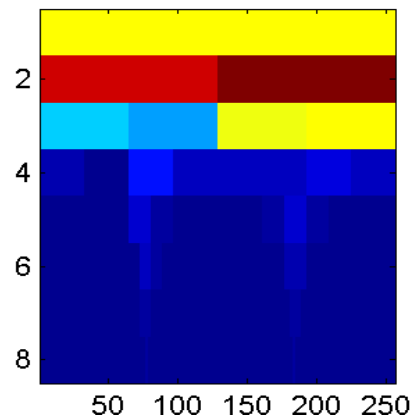
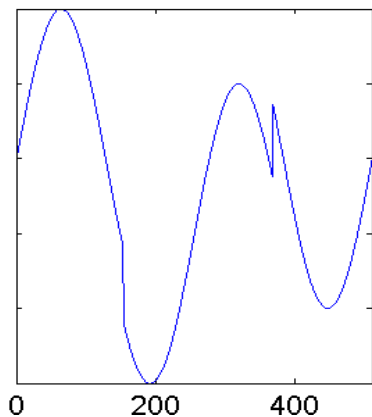
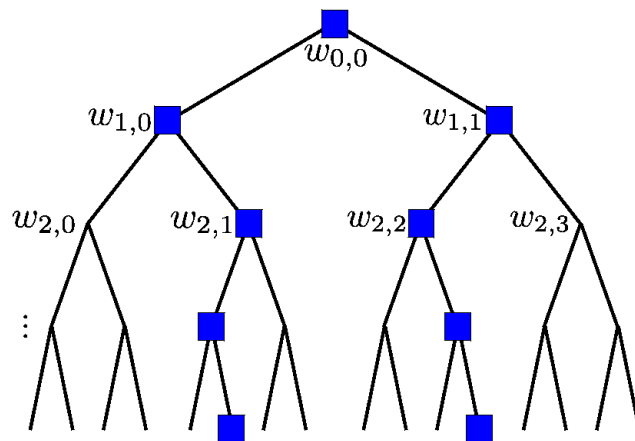

Other Useful Models

- Clustered coefficients

- tree sparse
- block sparse
- Ising models

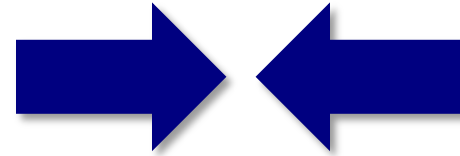

- Dispersed coefficients

- spike trains
- pulse trains

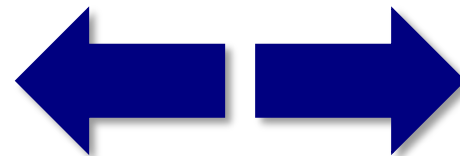

Finite Rate of Innovation

Continuous-time notion of sparsity: “rate of innovation”

Examples:

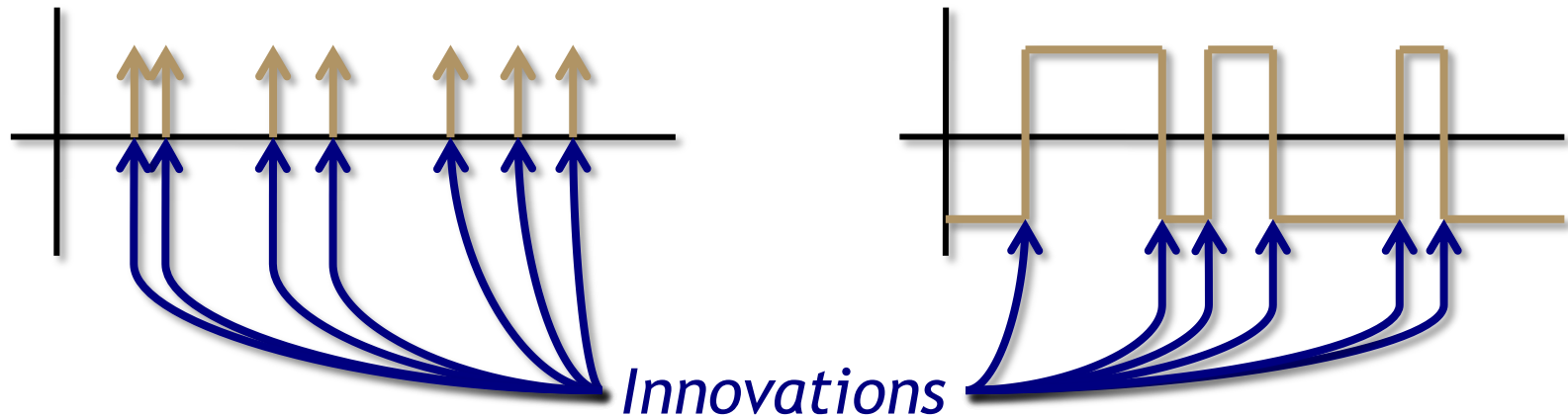

Rate of innovation:

Expected number of innovations per second

Sampling Signals with FROI

We would like to obtain samples of the form

$$y[m] = \phi(t) * x(t)|_{t=mT_s} = \langle \phi(mT_s - t), x(t) \rangle$$

where we sample at the *rate of innovation*.

Requires *careful construction of sampling kernel* $\phi(t)$.

Drawbacks:

- need to repeat process for each signal model
- stability

Manifolds

- S -dimensional *parameter* $\theta \in \Theta$ captures the degrees of freedom of signal
- Signal class forms an S -dimensional *manifold*
 - rotations, translations
 - robot configuration spaces
 - signal with unknown translation
 - sinusoid of unknown frequency
 - faces
 - handwritten digits
 - speech
 - ...

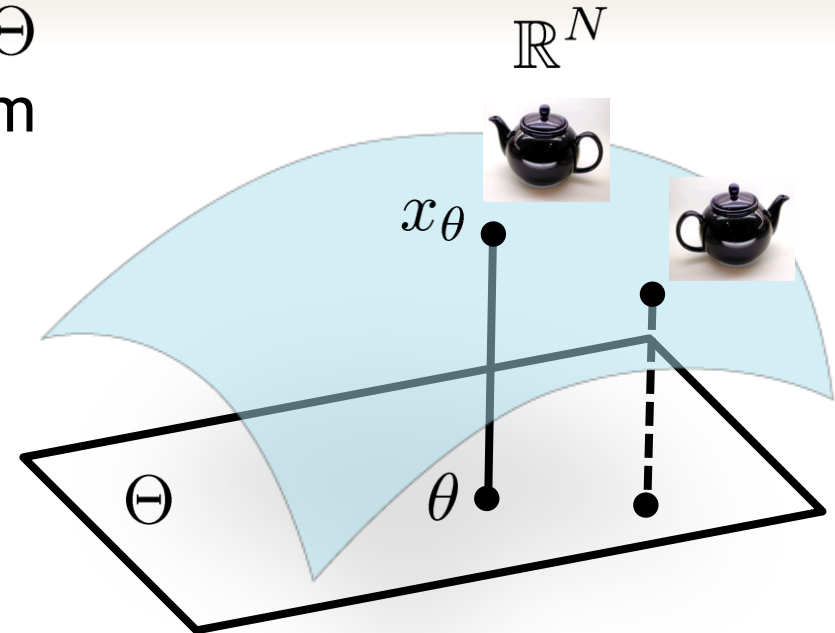

Random Projections

- For sparse signals, random projections preserve geometry

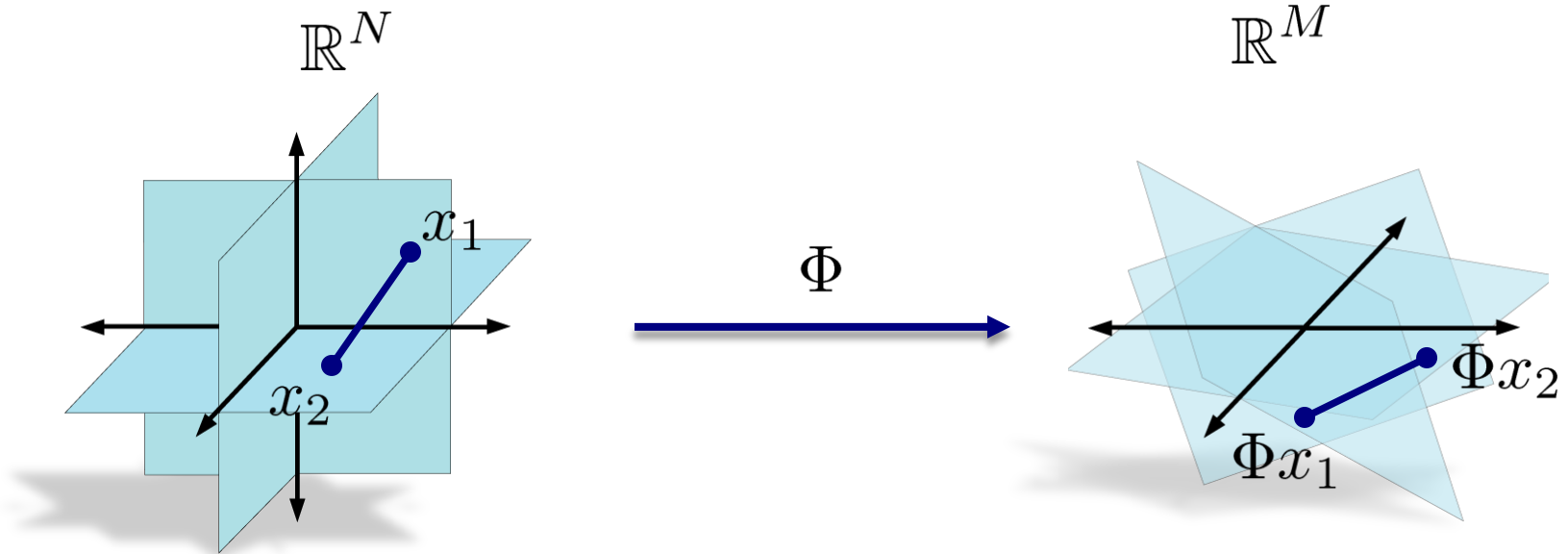

- What about manifolds?

Whitney's Embedding Theorem (1936)

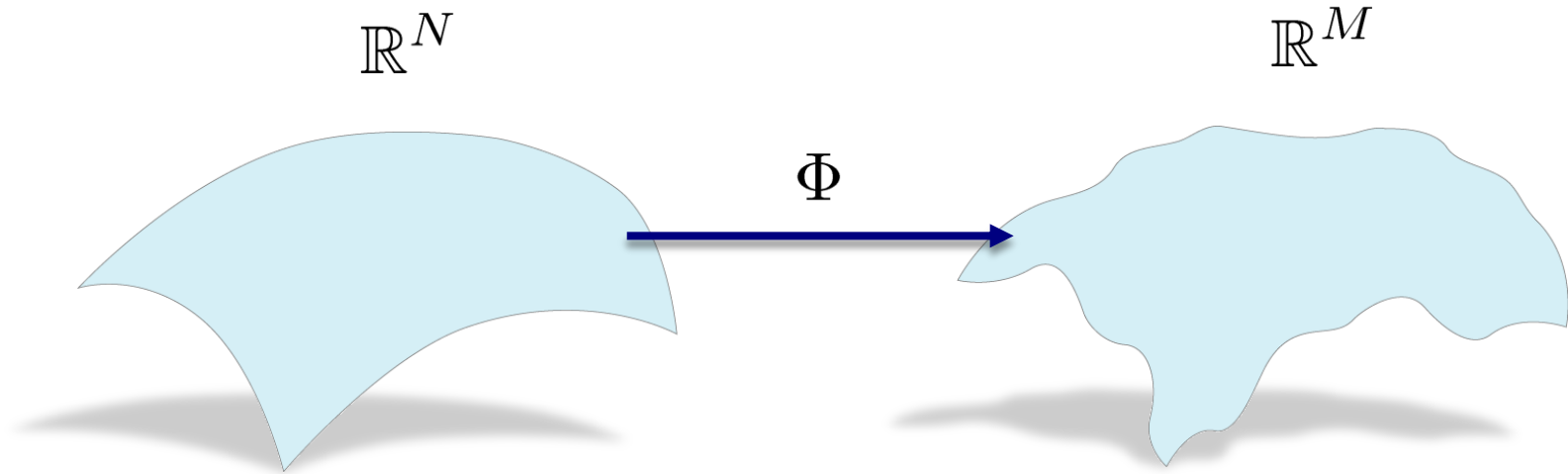

S -dimensional
smooth
compact

$M > 2S$ random
projections suffice
to embed the
manifold...

But *very unstable!*

Stable Manifold Embedding

Theorem

Let $\mathcal{M} \subseteq \mathbb{R}^N$ be a compact S -dimensional manifold with

- condition number $1/\tau$ (curvature, self-avoiding)
- volume V

Let Φ be a random $M \times N$ projection with

$$M = O(S \log(NV/\tau))$$

Then with high probability, and any $x_1, x_2 \in \mathcal{M}$

$$1 - \delta \leq \frac{\|\Phi x_1 - \Phi x_2\|_2^2}{\|x_1 - x_2\|_2^2} \leq 1 + \delta$$

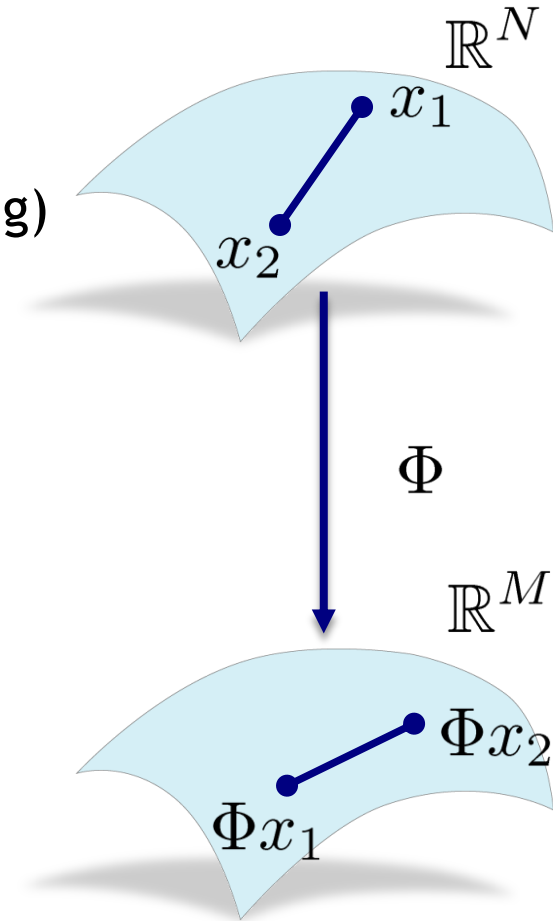

Stable Manifold Embedding

Sketch of proof

- construct a sampling of points
 - on manifold at fine resolution
 - from local tangent spaces
- apply JL lemma to these points

$$M = O(S \log(NV/\tau))$$

- extend to entire manifold

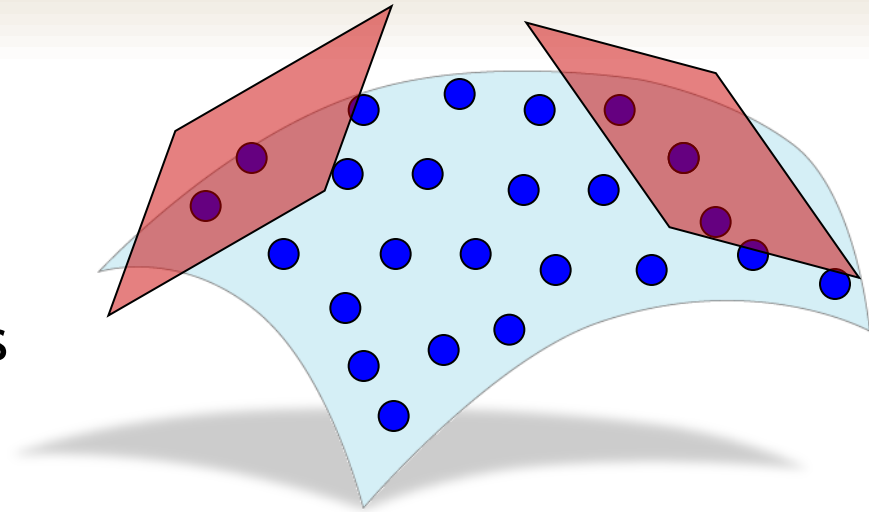

Implications

Nonadaptive (even random) linear projections can efficiently capture & preserve structure of manifold

See also: Indyk and Naor, Agarwal et al., Dasgupta and Freund

Compressive Sensing with Manifolds

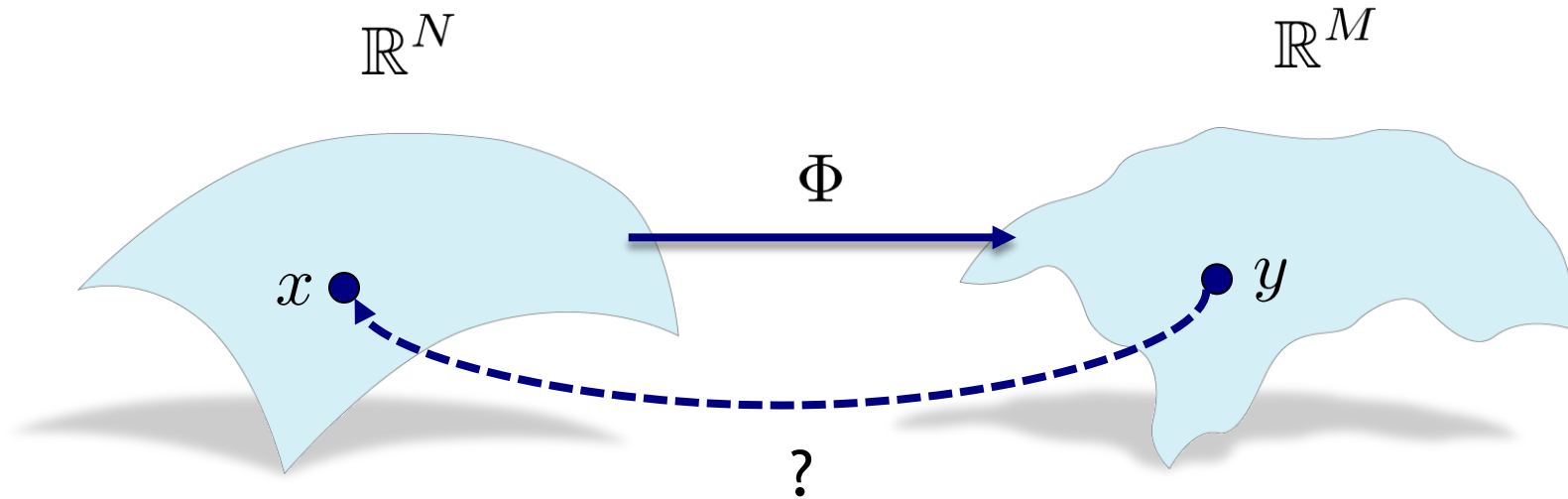

- Same sensing protocols/devices
- Different reconstruction models
- Measurement rate depends on *manifold dimension*
- Stable embedding guarantees robust recovery

Low-Rank Matrices

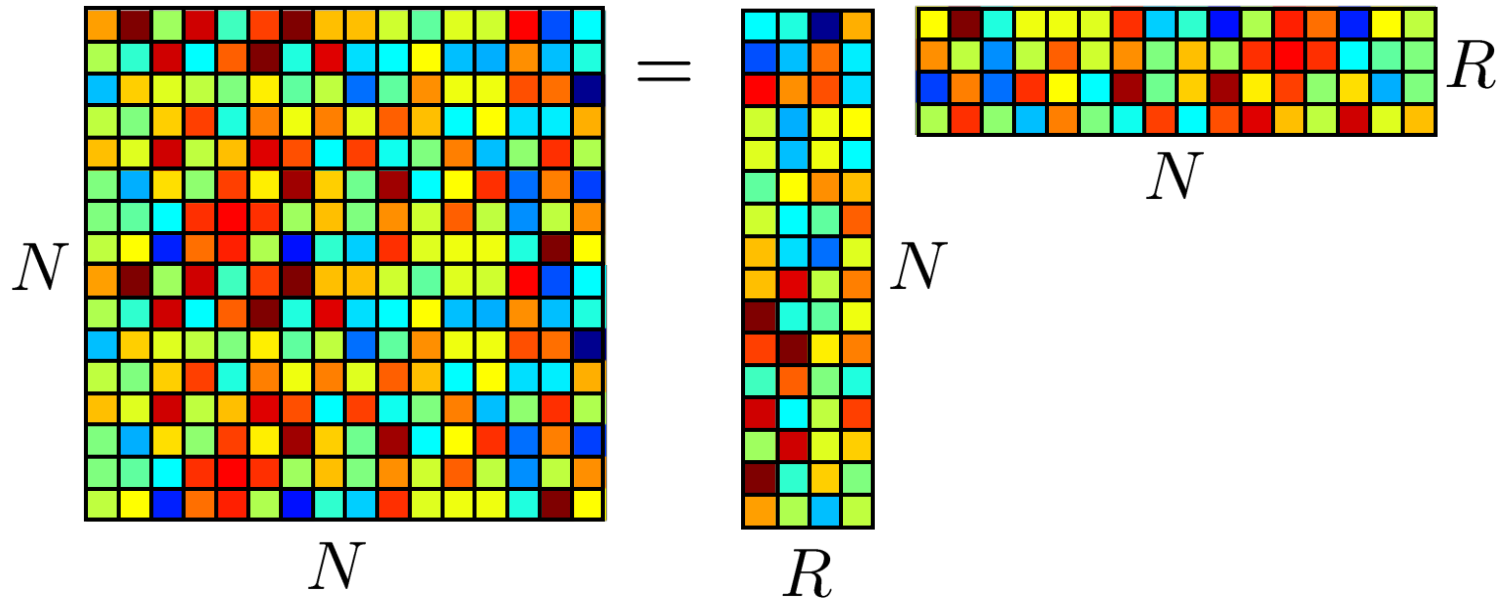

Singular value decomposition:

$$X = U\Sigma V^* \quad \longrightarrow \quad \approx NR \ll N^2$$

degrees of freedom

Matrix Completion

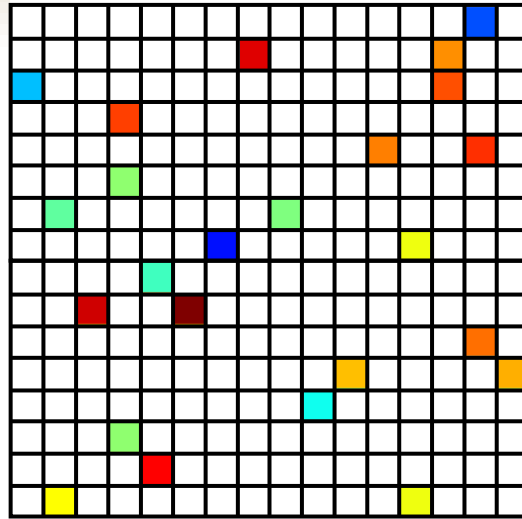

- Collaborative filtering (“Netflix problem”)
- How many samples will we need?

$$M \geq CNR$$

- Coupon collector problem

$$M \geq N \log N$$

Low-Rank Matrix Recovery

Given:

- an $N \times N$ matrix X of rank R
- linear measurements $y = \mathcal{A}(X)$

How can we recover X ?

$$\hat{X} = \arg \inf_{X: \mathcal{A}(X)=y} \text{rank}(X)$$

Can we replace this with something computationally feasible?

Nuclear Norm Minimization

Convex relaxation!

Replace $\text{rank}(X)$ with $\|X\|_* = \sum_{j=1}^N |\sigma_j|$

The “nuclear norm” is just the ℓ_1 -norm of the vector of singular values

$$\hat{X} = \arg \inf_{X: \mathcal{A}(X)=y} \text{rank}(X)$$

Nuclear Norm Minimization

Convex relaxation!

Replace $\text{rank}(X)$ with $\|X\|_* = \sum_{j=1}^N |\sigma_j|$

The “nuclear norm” is just the ℓ_1 -norm of the vector of singular values

$$\hat{X} = \underset{X: \mathcal{A}(X)=y}{\text{arg inf}} \|X\|_*$$

$$M = O(NR \log N)$$

Conclusions

Conclusions

- The theory of compressive sensing allows for new sensor designs, but requires new techniques for signal recovery
- We can still use compressive sensing even when signal recovery is not our goal
- “Conciseness” has many incarnations
 - structured sparsity
 - finite rate of innovation, manifold, parametric models
 - low-rank matrices
- The theory/techniques from compressive sensing can be tremendously useful in a variety of other contexts